

# Instruction Manual

*for*

# PIT STOP

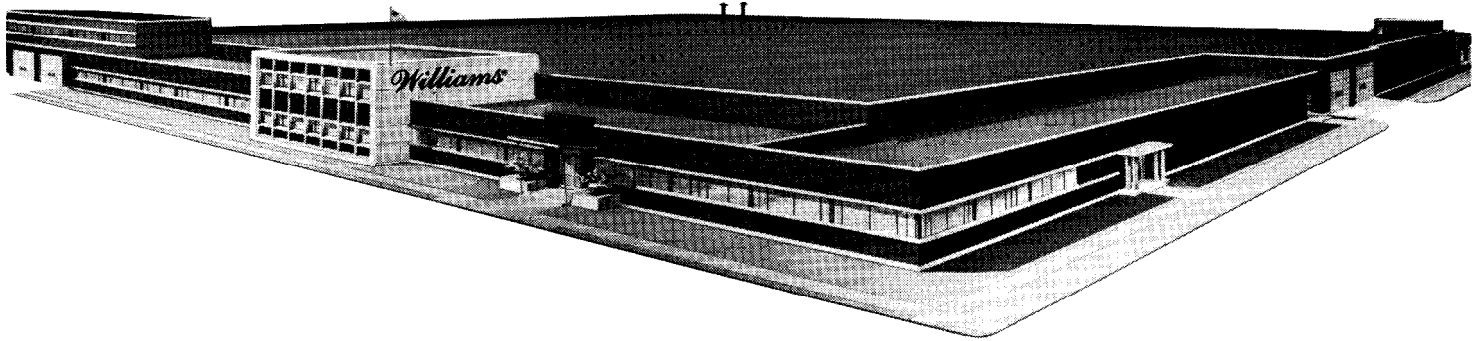

*Williams*<sup>®</sup> ELECTRONICS, INC.  
SUBSIDIARY OF THE SEEBURG CORPORATION

3401 N. California Ave.  
Phone 267-2240

Chicago, Ill. 60618, U.S.A.  
Cable Address: Wilcoin

# **IMPORTANT NOTICE**

**KINDLY INFORM LOCATIONS THAT THEY CAN TURN DISPLAY LIGHTS ON BY PRESSING LEFT FLIPPER BUTTON. MACHINE CAN STILL BE SHUT OFF BY TAPPING BOTTOM OF CABINET.**

**MASTER SWITCH (ON-OFF) IS LOCATED UNDERNEATH FRONT PART OF CABINET.**

## **CAUTION!**

The playboard on this machine has an improved finish with excellent wearing properties. Do not under any circumstances clean the board with water, water soap solutions or harsh abrasives. Avoid such things as steel wool, kitchen cleansers or abrasive hand soap. Water will weaken the adhering of the paint to the board and abrasives shorten the board life by many thousand plays. A wax base cleaner with negligible abrasive qualities used lightly, but frequently, will extend the board life to its full capabilities.

---

## **SERVICEMAN TO REMOVE BACKGLASS:**

- **WITH BACK DOOR REMOVED, PULL BACK ON BRACKETS AT INSIDE TOP OF LITE BOX.**
- **FROM THE FRONT OF GAME, LIFT GLASS UP AND OUT.**

# INSTRUCTIONS FOR ALTERING COIN CHUTES EQUIPPED WITH A FLIP-OVER DEVICE.

FOR 1 COIN-FOR 1 PLAY

OR

2 COINS - FOR 1 PLAY

**FIGURE 1**

**FIGURE 2**

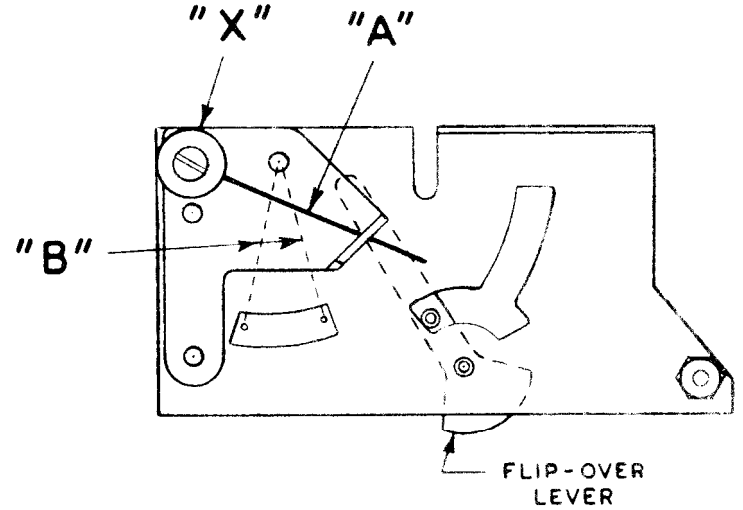
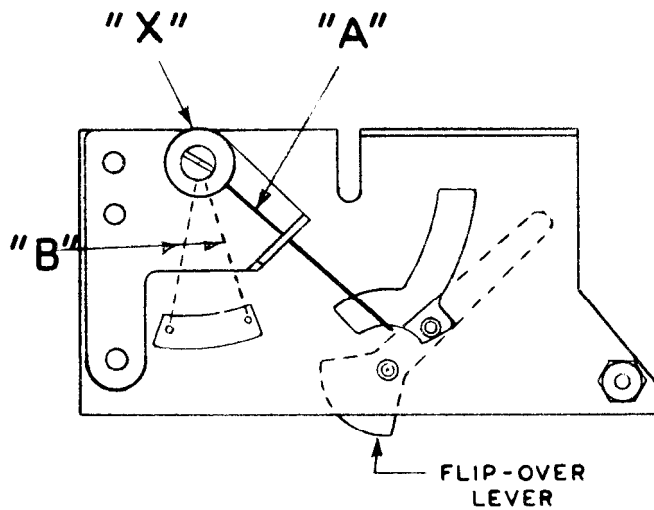

**1 COIN - FOR 1 PLAY (FIGURE 1):**

Wire form "A" should be in position as shown in Figure 1. Flip-over lever should rebound from wire form "A" and return to position shown in Figure 1 everytime a coin is inserted. All coins pass over the coin trip switch wire "B".

**2 COINS - FOR 1 PLAY (FIGURE 2):**

Wire form "A" should be in position as shown in Figure 2 (see note). Flip-over lever should alternate from side to side. 1st coin should go to cash box without actuating coin trip switch wire "B", 2nd coin should pass the coin trip switch wire "B" and returns flip-over to position as shown in Figure 2.

**NOTE:**

To change from 1 coin play to 2 coin play or vice versa - loosen screw "X" and move screw, bushing & wire form "A" to position as required - shown in Figure 1 position as required - shown in Figure 1 or Figure 2.

When using 1 coin for 1 play, wire form "A" should not under any circumstances be allowed to enter the "Banana" slot and cause binding of flip-over lever.

# INSTRUCTIONS FOR COIN TRIP SWITCH ADJUSTMENT

WIRE SHOULD BE IN CONTACT WITH END OF CRESCENT OPENING WHEN BLADE ADJUSTMENT IS MADE.

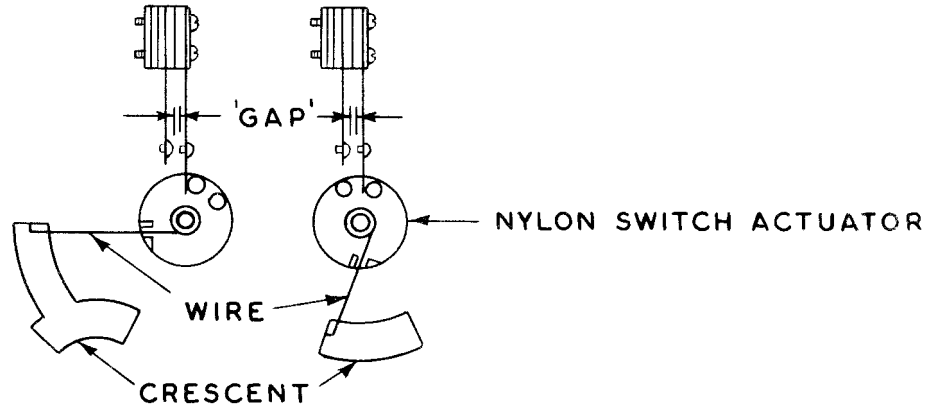

Long blade should be in contact with nylon switch actuator and have a maximum overtravel of 1/32.

or

Using a gram gauge, tension of long blade should not exceed 10 grams.

## SWITCH ADJUSTMENT

1. For small coins, such as dimes, adjust short blade so that the 'gap' between the silver contacts is .045 to .055.
2. For larger & heavier coins the 'gap' should be .045 to .060.
3. Do not adjust 'gap' closer than .040.

# WARRANTY

THE MOTORS IN ALL NEW WILLIAMS PRODUCTS  
ARE UN-CONDITIONALLY GUARANTEED FOR  
6 MONTHS FROM DATE OF PURCHASE.

ANY DEFECTIVE MOTORS RETURNED DURING THE  
WARRANTY PERIOD WILL BE REPLACED FREE OF  
CHARGE BY YOUR WILLIAMS DISTRIBUTOR.

## IMPORTANT NOTICE

WHEN ORDERING PARTS ALWAYS SPECIFY NAME OF  
UNIT, GAME AND SERIAL NUMBER, IN ADDITION TO A  
CLEAR DESCRIPTION OF THE PART AND PART  
NUMBER IF POSSIBLE.

UNIT PARTS LIST "PIT STOP"

UNIT NAME	CONTACT DISC	WIPER ASSEMBLY	RATCHET GEAR ASSEMBLY	MOTORS
REPLAY	-----	-----	A-6400	
BALL COUNT	C-6878	C-6520	A-6402-10	
ADVANCE	C-6417	C-6520	A-6401	
NO. MATCH	C-6879	C-6520	A-6401	14A-7805 (60 CYCLE)
0-9	B-6297	A-6294	3C-7128	14A-7806 (60 CYCLE)
TENS	-----	-----	3C-7128	
HUNDREDS	B-6297	A-6294	3C-7128	
THOUSANDS	B-6297	A-6294	3C-7128	
0-9 LAP	B-6297	A-6294	3C-7128	
TENS LAP	B-6297	A-6294	3C-7128	

"PIT STOP" COIL CHART

NOTICE:

THIS GAME OPERATES ON 24 VOLTS. WHEN ORDERING REPLACEMENT TRANSFORMERS, MOTORS, COILS OR METERS ... MAKE SURE TO SPECIFY CORRECT PART NUMBER.

NUMBER	DESCRIPTION	LOCATION
14 A 7805	SCORE MOTOR - 60 CYCLE	MECH. PANEL
14 A 7806	SCORE MOTOR - 50 CYCLE	MECH. PANEL
15 A 6771	TRANSFORMER - 60 CYCLE	MECH. PANEL
15 A 6773	TRANSFORMER - 50 CYCLE	MECH. PANEL
B 6396	24 VOLT METER	MECH. PANEL
<u>SOLENOID COILS</u>		
A 22-550	BALL RELEASE	PLAYFIELD
	BALL COUNT UNIT STEP UP	INSERT
	MATCH UNIT STEP UP	INSERT
	1st PLAYER ADVANCE STEP UP	PLAYFIELD
	2nd PLAYER ADVANCE STEP UP	PLAYFIELD
A 23-600	REPLAY UNIT STEP UP	INSERT
A2-23-750	LARGE BELL KNOCKER	CABINET CABINET
B 26-800	REPLAY UNIT RESET	INSERT
	BALL COUNT UNIT RESET	INSERT
	SCORE DRUM UNITS ... (12 req'd.)	INSERT
FL 21-375/ 28-400	FLIPPERS ... (2 req'd.)	PLAYFIELD
G 22-550	JET BUMPERS ... (3 req'd.)	PLAYFIELD
G 23-750	AUTOMATIC KICKERS ... (2 req'd.)	PLAYFIELD
<u>RELAY COILS</u>		
M 29-1000	2nd COIN(TRIP) GAMEOVER TRIP	MECH. PANEL MECH. PANEL
M 29-1100	1st PLAYER RESET	INSERT
	#1 BUMPER	PLAYFIELD
	#2 BUMPER	PLAYFIELD
	#3 BUMPER	PLAYFIELD
	1 POINT	INSERT
	10 POINT	INSERT
	100 POINT	INSERT
	10¢ RELAY	MECH. PANEL
	25¢ RELAY	MECH. PANEL
	FINISH	PLAYFIELD
	LAP	PLAYFIELD
	5 ADVANCE	PLAYFIELD
	R.O. RELAY	PLAYFIELD
	ADVANCE RELAY	PLAYFIELD
	200 POINT	PLAYFIELD
	2nd PLAYER RESET	INSERT
M1-31-1500	COIN LOCKOUT COIL	DOOR
XM 27-675	METER COIL	MECH. PANEL
Z 27-1000	OUTHOLE RELAY	MECH. PANEL
	RESET RELAY	MECH. PANEL
	2nd COIN RELAY (LATCH)	MECH. PANEL
	GAMEOVER (LATCH)	MECH. PANEL
	COIN RELAY	MECH. PANEL
	REPLAY RELAY	MECH. PANEL
Z 28-1150	LOCK RELAY	MECH. PANEL
	PLAYER RELAY	INSERT
	PLAYER "A" RELAY	INSERT
	TILT RELAY	MECH. PANEL
	CHANGE RELAY	PLAYFIELD
	EXTRA BALL	MECH. PANEL
Z 28-1200	ON LEFT BUMPER	PLAYFIELD
	ON RIGHT BUMPER	PLAYFIELD
	BALL INDEX	MECH. PANEL

# ADJUSTMENTS IN BACKBOX

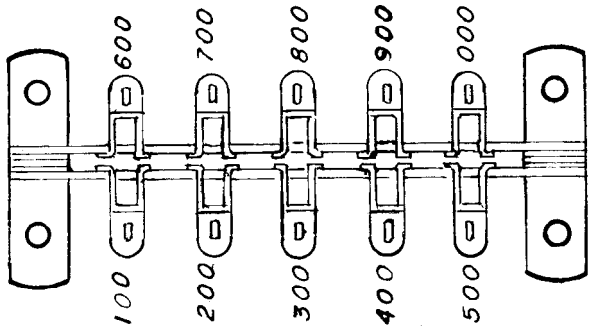

- RED- (1100 to 2000)
- BLUE- (2100 to 3000)
- YELLOW- (3100 to 4000)
- GREEN- (4100 to 5000)
- WHITE- (5100 to 6000)
- BROWN- (6100 to 7000)
- ORANGE- (7100 to 8000)

## HI-Score Adjustment

Insert plugs into 10 Point Female at desired positions.

Examples:

- Yellow wire into 300 position scores at 3300.
- Yellow wire into 000 position scores at 4000.

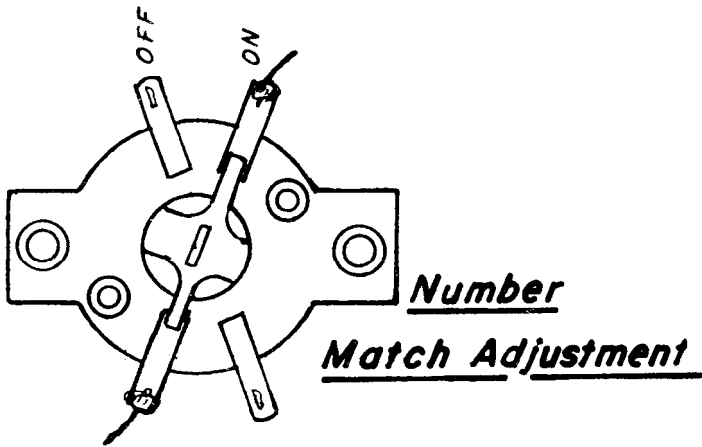

In "ON" position, a number match lite will appear when game is over. This number will match the last number in point score, on the average, once every ten games. In "OFF" position, Number Match is inoperative.

## 3-5 Ball Adj. Jack

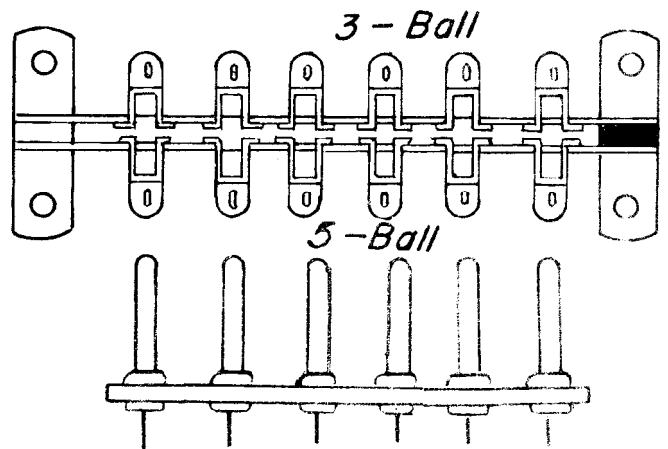

Plug changes 3 to 5 ball play or vice versa.

## Lap Adjustment

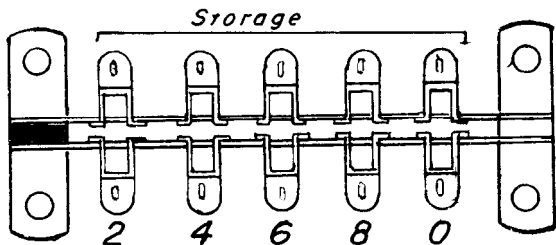

- RED (2-10)
- YELLOW (12-20)
- GREEN (22-30)

**INSERT PLUGS INTO POSITIONS DESIRED.**

**For Example:-**

- Red Wire into "0" position scores at 10 laps.
- Yellow Wire into "6" position scores at 16 laps



# ADJUSTMENTS ON MECHANISM PANEL

## 10¢ Adjustment

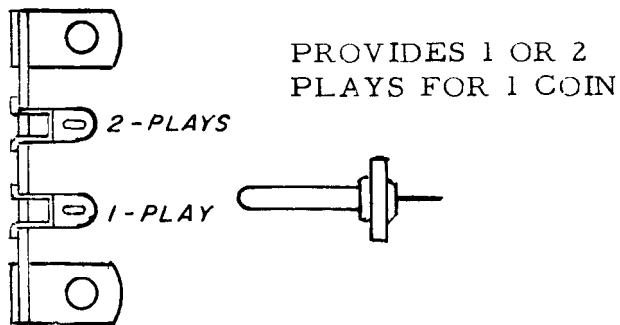

## Motor Service Jack

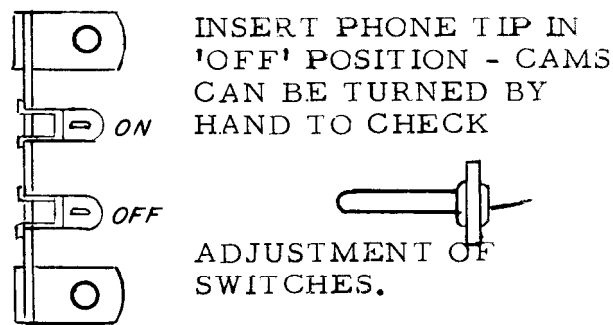

## 25¢ Adjustment

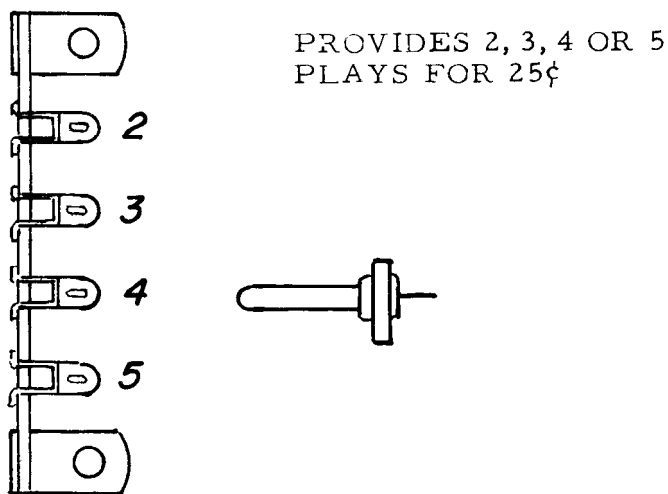

## Extra Ball Jack Adj.

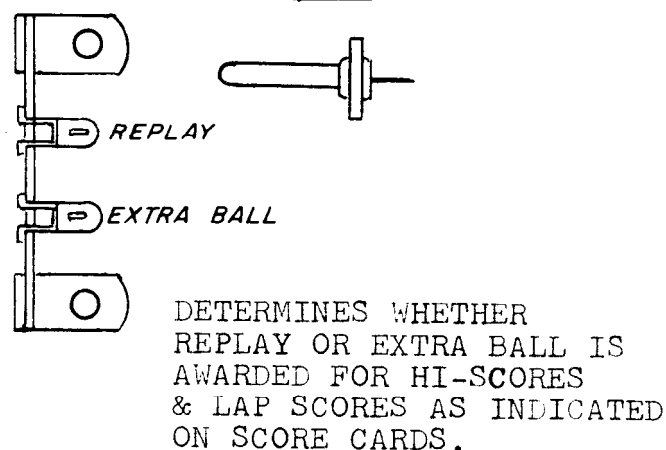

## MASTER ON-OFF SW.

(Located under front of Cabinet)

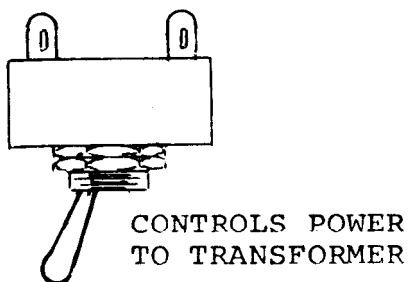

## ROLL-UP EXTRA BALL ADJ.

(Left Side)  
Located in Backbox

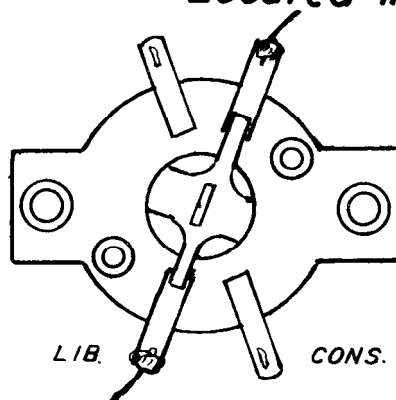

SIDE ROLL UP LITES FOR EXTRA BALL AS FOLLOWS:  
LIBERAL -- AT ZERO AND 5TH POSITIONS ON ADVANCE UNITS.  
CONSERVATIVE -- AT ZERO POSITIONS ONLY.

### SUGGESTED SCORE CARDS:

5 BALL PLAY .....	342-13	LAPS... 342-5A
3 BALL PLAY .....	342-2	LAPS... 342-3A

# "PIT STOP" - POST ADJUSTMENT SHEET

TO MAKE GAME MORE "CONSERVATIVE" OR "LIBERAL" - MOVE POSTS 3/16" AS SHOWN IN SKETCH BELOW. SPOTTING HOLES ARE PROVIDED AND CAN BE SEEN ON REMOVAL OF POSTS.

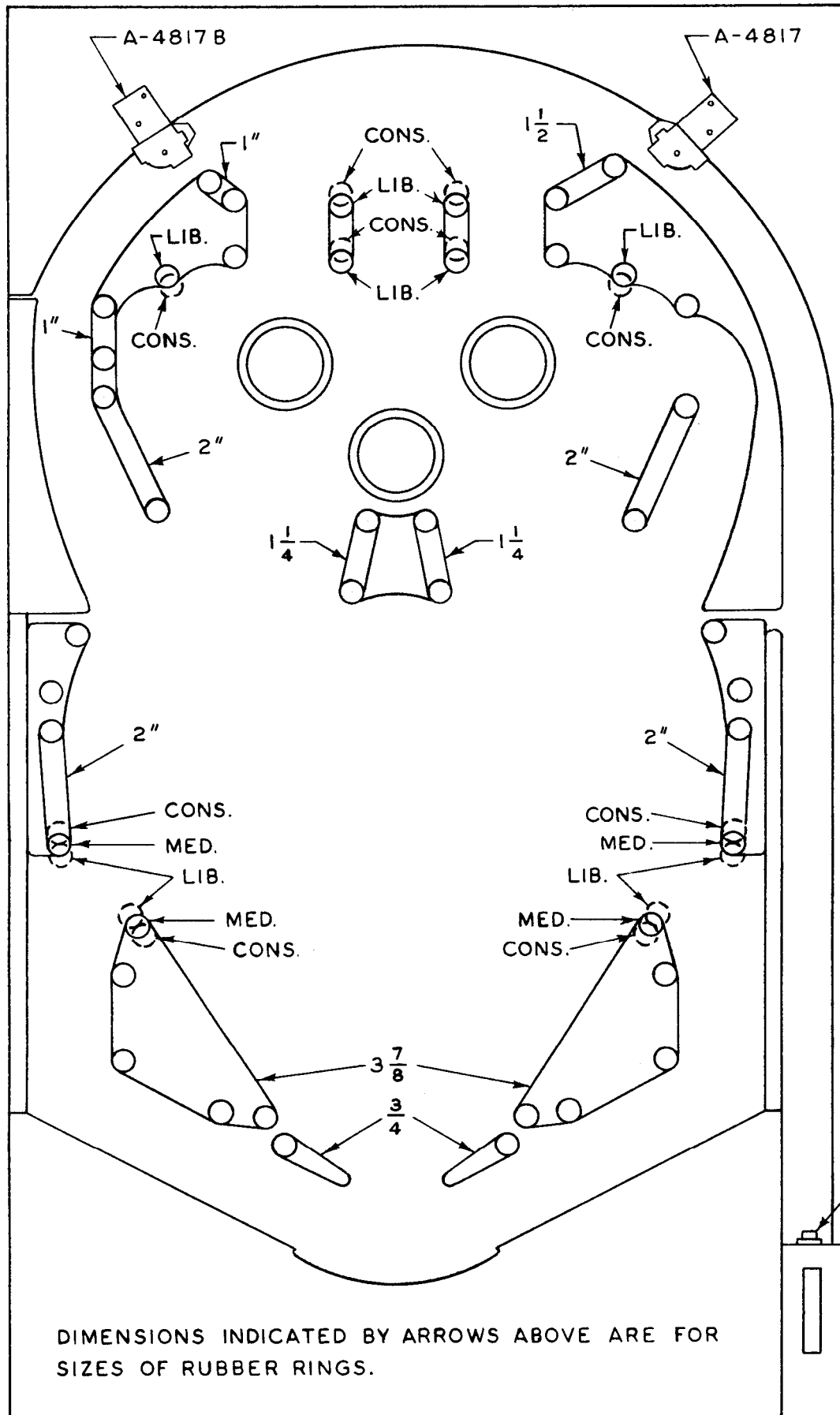

## ABBREVIATIONS :

CONS.- CONSERVATIVE  
LIB. - LIBERAL  
MED. - MEDIUM

## RUBBER RING NUMBERS :

23A-6300	5/16" I.D.
23A-6301	3/4" I.D.
23A-6302	1" I.D.
23A-6303	1 1/4" I.D.
23A-6304	1 1/2" I.D.
23A-6305	2" I.D.
23A-6309	3 7/8" I.D.

A-4817 - BALL GATE ASS'Y. (R)  
A-4817B - BALL GATE ASS'Y. (L)

23A-6327 - BALL SHOOTER  
RUBBER TIP

DIMENSIONS INDICATED BY ARROWS ABOVE ARE FOR SIZES OF RUBBER RINGS.

## 1. GENERAL

NEVER EXPERIMENT with any of the mechanism. Locate any trouble with the aid of Wiring Diagrams or Operating & Servicing Information supplied with the machine, then check for proper adjustment of the units involved before making any changes. Improper adjustment or make-shift repair will only cause serious damage to other parts of the machine or repeated failure of the part.

NOTE: Always look for a possible loose wire, bad connection at a plug and socket, broken or unhooked springs on step-up units, relays, etc., before adjustments are made or wires reconnected.

## 2. FUSES

IMPORTANT: Never replace fuses with any rating other than specified on the fuse block; this block is located adjacent to the transformer.

## 3. LUBRICATION

Over-lubrication causes far more trouble in coin operated equipment than under-lubrication. Practically all cases of poor contact on switches and wiper discs are due to oil or grease, or oil vapor, which forms a film or residue on the contacts and will not allow current to pass through. Excess lubricant may also seep into clutches causing them to slip.

IMPORTANT: NEVER USE VASELINE FOR LUBRICATION OF ANY PART OF THE MACHINE. Vaseline is not a true lubricant. It leaves a dirty and gummy residue and it becomes very thick when cold. A special Coin Machine Lubricant is supplied with each machine.

STEP-UP Levers, Ratchets, Cams, Shafts and other sliding or oscillating parts should be very lightly greased with special Coin Machine Lubricant (supplied with machine) not oftener than every six months. The bakelite discs (biscuits) on the Motor Units and Step-up Units will require lubrication with the special Coin Machine Lubricant only after the grease is completely evaporated (3 to 12 months, depending on climate) or when the film of grease becomes dirty. In either event, clean the parts thoroughly with a solvent, then apply an extremely thin coat of the special grease.

Solenoid Plungers should not have a lubricant of any kind. Should there be a sluggish tendency or if plungers are sticking, the parts should be cleaned with a solvent and flaked graphite applied on reassembly.

## 4. RELAY and SWITCH ADJUSTMENT

Where relay adjustments are called for, before bending blades, in all cases, on any machine, make certain that the screws holding the switch stacks are down very tightly. This is suggested because the plastic spacers in the switch stacks have occasionally shrunk by drying out, causing a poor adjustment.

# PLAYFIELD LAYOUT SHOWING LOCATION OF TARGETS, ROLL OVERS, AND JET BUMPERS

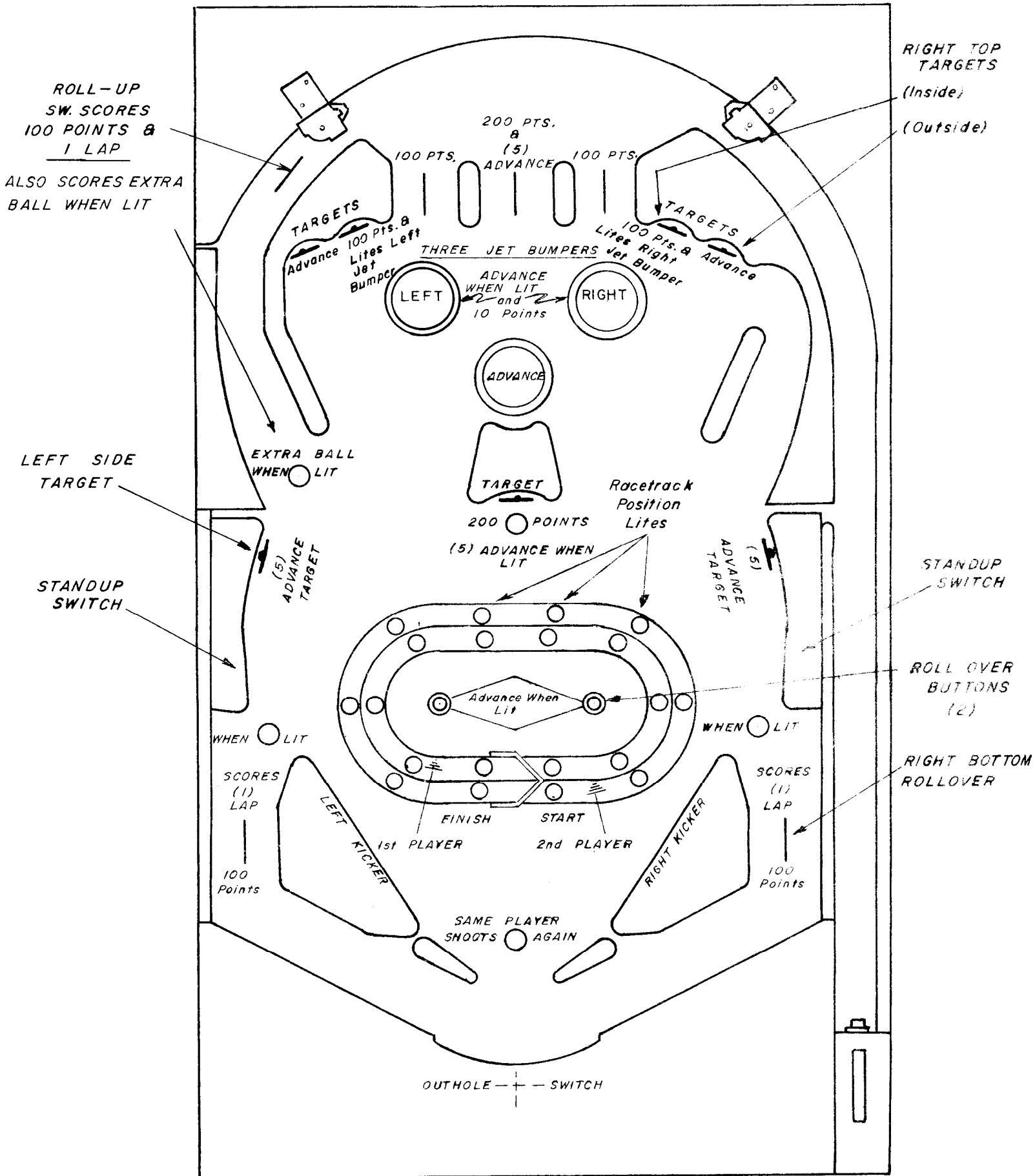

## "PIT STOP"

### "PIT STOP" OPERATES AS FOLLOWS:

RACETRACK POSITION LITES ARE CONTROLLED BY 1st AND 2nd PLAYER ADVANCE UNIT DISCS. WHEN THE ADVANCE UNIT STEPS UP TEN TIMES, A LAP IS COMPLETED AND REGISTERS ON THE LAP DRUM UNIT FOR THAT PLAYER.

THE ADVANCE UNIT TAKES ONE STEP WHEN THE FOLLOWING SWITCHES ARE MADE:

CENTER JET BUMPER.  
LEFT OR RIGHT JET BUMPER, WHEN LIT.  
LEFT TOP OR RIGHT TOP (OUTSIDE) TARGET.  
LEFT OR RIGHT ROLLOVER BUTTON, WHEN LIT.

THE ADVANCE UNIT TAKES 5 STEPS WHEN THE FOLLOWING SWITCHES ARE MADE:

TOP CENTER ROLLOVER.  
LEFT SIDE OR RIGHT SIDE TARGET.  
CENTER TARGET, WHEN LIT.

THE ADVANCE UNIT STEPS UP TO THE START POSITION (COMPLETING A LAP) BY MAKING THE LEFT ROLL-UP SWITCH. ALSO BY MAKING THE LEFT OR RIGHT BOTTOM ROLLOVER, WHEN LIT.

THE LEFT ROLL-UP, WHEN LIT, ENERGIZES THE EXTRA BALL RELAY. HI-SCORES AND LAP SCORES AWARD REPLAY OR EXTRA BALL, THRU THE "REPLAY-EXTRA BALL" ADJUSTMENT JACK. REFER TO PAGES 6 AND 7 FOR ADJUSTMENT JACKS.'

### POWER TRANSFORMER:

LOCATED ON MECHANISM PANEL. IT IS EQUIPPED WITH A SECONDARY TAP. IF YOUR GAME IS ON LOCATION WITH EXTREMELY LOW LINE VOLTAGE, REMOVE LEAD FROM LUG MARKED 24 VOLTS AND SOLDER TO ALTERNATE LUG MARKED "HIGH". THIS WILL BOOST SECONDARY VOLTAGE APPROXIMATELY 2-3 VOLTS.

### LEG LEVELERS:

ARE PROVIDED FOR TWO PURPOSES - 1st TO LEVEL GAME ON LOCATION, 2nd TO INCREASE PITCH FOR GAME PERCENTAGING. IF IT IS DESIRED TO SPEED UP PLAY AND DECREASE SCORES, RAISE REAR LEG LEVELERS TO INCREASE PITCH.

## Service Suggestions:

1. Lights are out, game is inoperative:
  - a. Check A.C. cord and plugs for breaks, cuts or other damage.
  - b. Check fuses, located behind cash box.
  - c. Check master switch, located under front of cabinet.
  - d. Check plugs and jacks for proper installation.
2. Lights are out, game operates:
  - a. Check two switches on Lock Relay: Blue-Yellow-White to Green-Yellow-White, and Brown-Yellow-White to Green-Yellow-White.
  - b. Check 10 AMP fuse-Blue wire, and 15 AMP fuse-Brown wire.
3. Game resets but Game Over Relay trips immediately:
  - a. Check switch on Lock Relay Blu-Red and Yellow.
  - b. Check Ball Count Unit Reset Coil.
  - c. Check Ball Count Unit and switches for proper resetting.
4. Game is over, replays are indicated, but the Replay Button fails to start a new game:
  - a. Check Make and Break Switch on Reset Relay (Blu and Yellow).
  - b. Check switch on Index Cam (Green-Red and Blu).
  - c. Check Replay Button Switch.
  - d. Check Replay Unit Zero Switch.
  - e. Check switch on Game Over Relay (White-Brown and Green-Orange).
  - f. Check Replay Relay Coil.
5. Ball Count Unit fails to advance during play:
  - a. Check Make-Break sw. on Outhole Relay (Red-White and Yellow).
  - b. Check sw. on Extra Ball Relay (Red-White and Red-Orange).
  - c. Check sw. on Ball Index Relay (Red-Orange and Orange-Black).
  - d. Check Score Motor Cam Sw. 2A (Orange-Black and Red-White).
  - e. Check Ball Count S.U. coil.
6. The sequence of operation when ball makes Left Side Roll-Up switch is as follows:
  1. Left Side Roll-Up switch pulses R-O Relay.
  2. Switch C on R-O Relay pulses 100 Point Relay.
  3. Switch B on R-O Relay energizes Extra Ball Relay if "Extra Ball When Lit" is on.
  4. Switch A on R-O Relay energizes Lap Relay.
  5. Switch C on Lap Relay runs Score Motor.
  6. Switch B on Lap Relay pulses 1st or 2nd Player Advance Unit S.U., thru Impulse Cam switch B.
  7. Lap Relay remains energized until Finish Relay is pulsed.
  8. Finish Relay is pulsed by End-Of-Stroke switch on Advance Unit, thru rivet #1 on Advance Unit disc.

# No. MATCH UNIT

THIS UNIT ADVANCES ONE STEP EACH TIME THE ONE POINT RELAY IS PULSED.

View looking at  
WIPER FINGER side

ENERGIZES CHANGE RELAY

IN No. MATCH CIRCUIT,  
THESE WIRES COME FROM  
THE 1-PT. D.U. DISC OF  
BOTH PLAYERS.

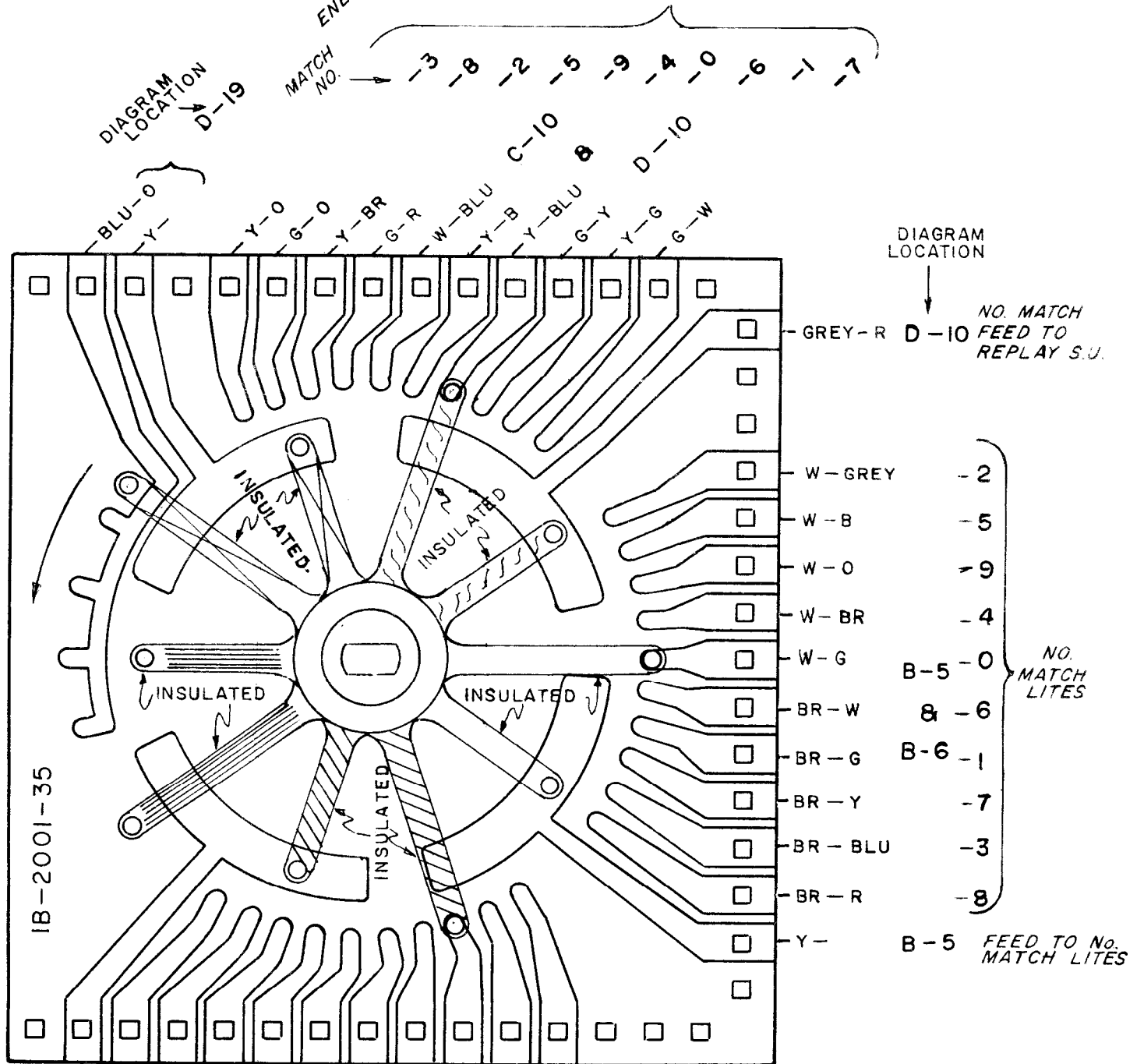

# 1st PLAYER ADVANCE UNIT DISC

THIS UNIT ADVANCES TO START POSITION, DURING RESET CYCLE, DURING PLAY, THIS UNIT ADVANCES:

- A - 1 STEP, THRU ADVANCE RELAY.
- B - 5 STEPS, THRU 5 ADVANCE RELAY.
- C - TO START POSITION, THRU LAP RELAY.

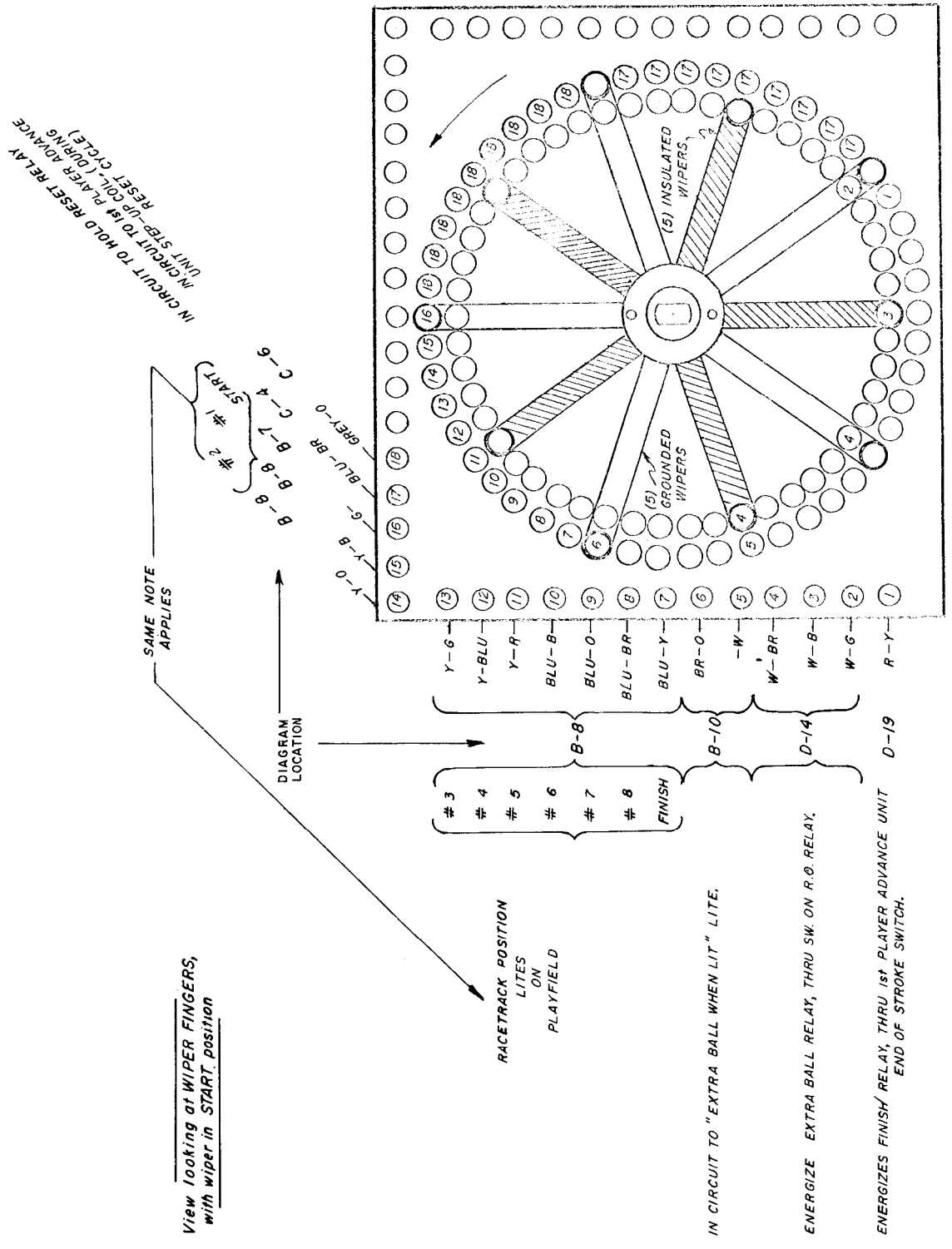

View looking at WIPER FINGERS, with wiper in START position



## 2nd PLAYER ADVANCE UNIT DISC

THIS UNIT ADVANCES TO START POSITION, DURING RESET CYCLE. DURING PLAY, THIS UNIT ADVANCES:-

- A-1 STEP, THRU ADVANCE RELAY.
- B-5 STEPS, THRU 5 ADVANCE RELAY.
- C-TO START POSITION. THRU LAP RELAY

SAME NOTE APPLIES  
# 1 IN CIRCUIT TO RESET RELAY. ADVANCE UNIT  
# 2 IN CIRCUIT TO 2nd PLAYER RESET CYCLE.

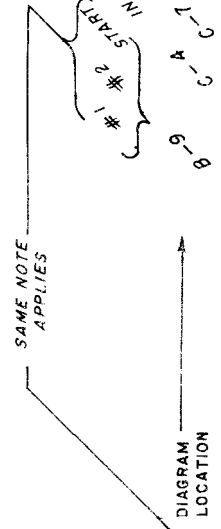

View looking at WIPER FINGERS  
with wiper START position

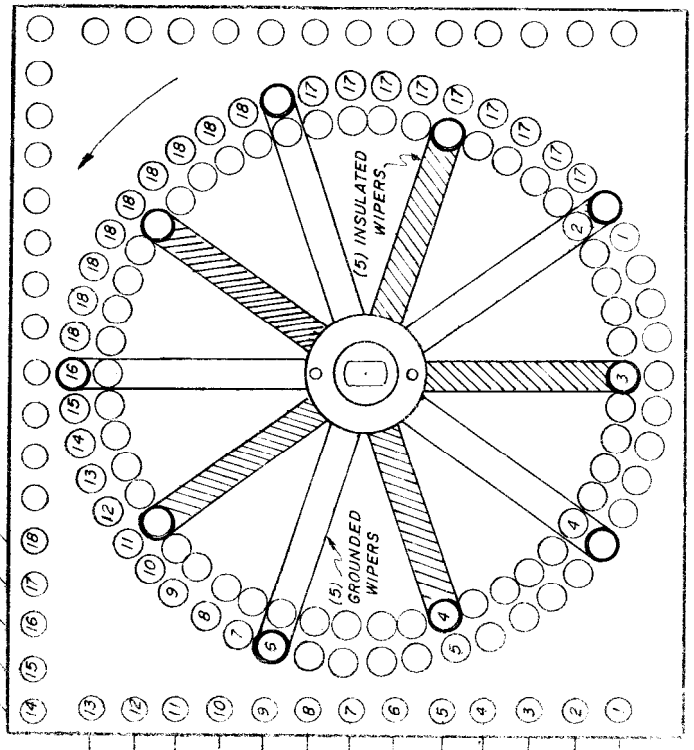

- # 3 RACETRACK POSITION LITES ON PLAYFIELD
- # 4
- # 5
- # 6
- # 7
- # 8
- FINISH
- B-9 IN CIRCUIT TO "EXTRA BALL WHEN LIT" LITE
- B-10 ENERGIZE EXTRA BALL RELAY, THRU SWITCH ON R.O. RELAY.
- D-14 ENERGIZES FINISH RELAY THRU 2nd PLAYER ADVANCE UNIT END OF STROKE SWITCH.
- D-19

# BALL COUNT UNIT

THIS UNIT RESETS AT THE START OF A NEW GAME. IT ADVANCES ONE STEP AT A TIME WHEN TWO PERSONS ARE PLAYING & TWO STEPS IF ONLY ONE IS PLAYING.

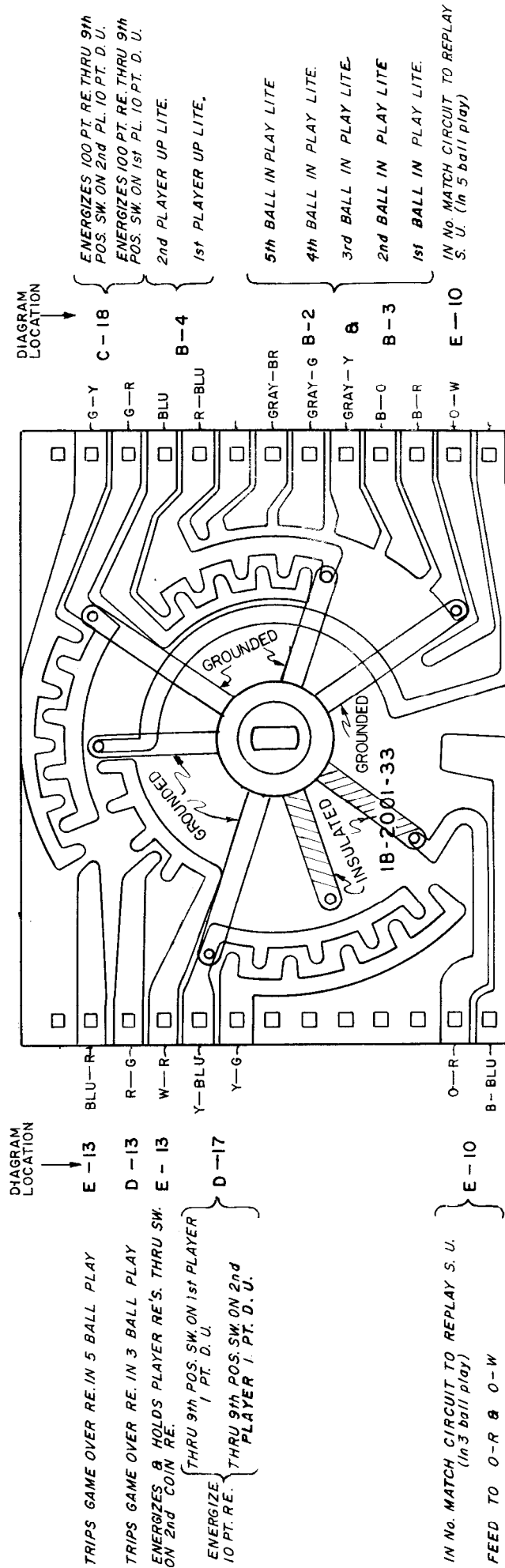

View looking at WIPER FINGERS with WIPER in RESET Position

# A.C. RELAYS & SWITCHES

## On Mechanism Panel

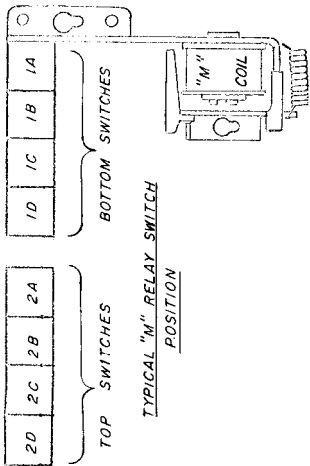

### 10¢ RELAY

IS ENERGIZED BY 10¢ COIN SWITCH, IF 10¢ ADJUSTMENT JACK IS IN "2" PLAYS " POSITION.

DIAGRAM LOCATION

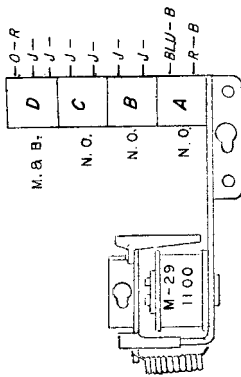

### OPERATION

E-5 IN CIRCUIT TO KNOCKER COIL---ALSO RUNS SCORE MOTOR.  
 E-9 PULSES REPLAY S.U. COIL, THRU IMPULSE CAM SWITCH A. ENERGIZES LOCK RELAY.  
 D-3 IN HOLD CIRCUIT TO THIS RELAY.  
 E-2 IN HOLD CIRCUIT TO THIS RELAY.

### 25¢ RELAY

IS ENERGIZED BY 25¢ COIN SWITCH.

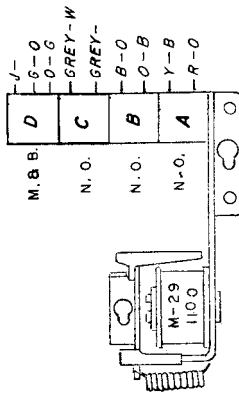

D-5 IN CIRCUIT TO KNOCKER COIL---ALSO RUNS SCORE MOTOR.  
 E-9 PULSES REPLAY S.U. COIL, THRU IMPULSE CAM SWITCH A. ENERGIZES LOCK RELAY.  
 D-3 IN HOLD CIRCUIT TO THIS RELAY.  
 E-2 IN HOLD CIRCUIT TO THIS RELAY.

### BALL INDEX RELAY

IS ENERGIZED BY TILT RELAY OR 100 POINT RELAY.

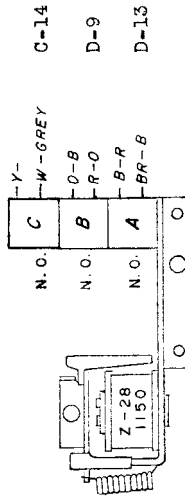

C-14 IN SERIES WITH SWITCH A ON EXTRA BALL RELAY.  
 D-9 ENERGIZES BALL COUNT S.U. COIL, THRU SWITCH D ON OUTHOLE RELAY.  
 D-13 IN HOLD CIRCUIT TO THIS RELAY.

### EXTRA BALL RELAY

IS ENERGIZED BY SWITCH B ON R-C RELAY, THRU 1ST OR 2ND PLAYER ADVANCE UNIT DISCS. IT IS ALSO ENERGIZED BY "HI-SCORE" AND "NO. MATCH" CIRCUITS, IF REPLAY-EXTRA BALL ADJUSTMENT JACK IS IN EXTRA BALL POSITION.

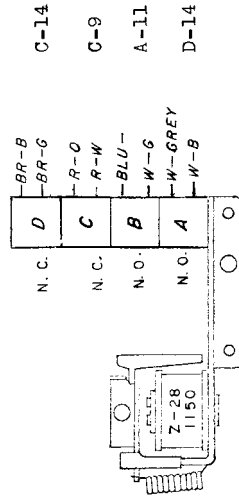

C-14 IN CIRCUIT TO BALL INDEX RELAY COIL, THRU SWITCH ON 100 POINT RELAY.  
 C-9 IN SERIES WITH SWITCH B ON BALL INDEX RELAY.  
 A-11 TO "SHOOT AGAIN" LITE.  
 D-14 IN HOLD CIRCUIT TO THIS RELAY.

**LOCK RELAY**

IS ENERGIZED BY COIN RELAY OR LEFT FLIPPER SWITCH.

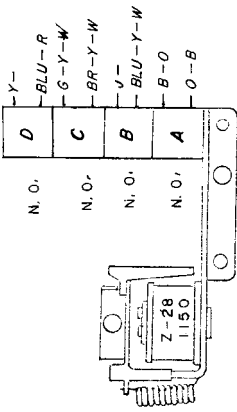

**RESET RELAY**

IS ENERGIZED BY THE COIN RELAY THRU A SWITCH ON GAME OVER RELAY.

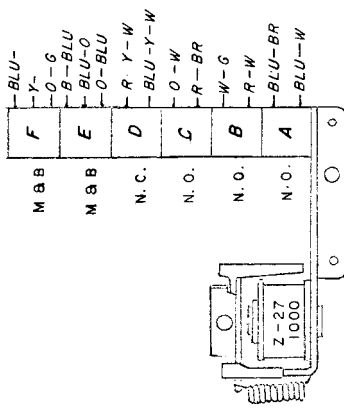

**REPLAY RELAY**

IS ENERGIZED BY REPLAY BUTTON SWITCH, THRU ZERO BREAK SWITCH ON REPLAY S.U.

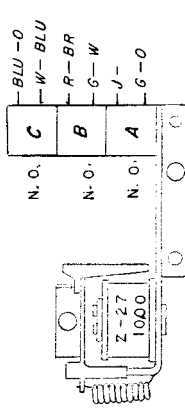

**COIN RELAY**

IS ENERGIZED BY COIN SWITCH OR BY REPLAY RELAY.

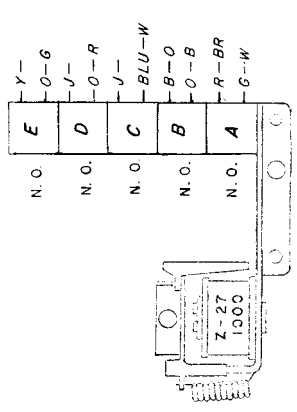

DIAGRAM LOCATION

**OPERATION**

C-12 ENERGIZES GAME OVER RELAY (TRIP COIL).

A-2 6 VOLTS TO LITES.

A-2 6 VOLTS TO LITES.

D-3 IN HOLD CIRCUIT TO THIS RELAY.

C-3 BREAKS CIRCUIT TO REPLAY RELAY DURING RESET CYCLE---ALSO RUNS SCORE MOTOR.

D-5 BREAKS CIRCUIT TO 2ND COIN RELAY (TRIP COIL) AND MAKES TO LATCH COIL.

F-10 BREAKS CIRCUITS TO ALL PLAYFIELD SWITCHES.

E-7 PULSES 2ND PLAYER ADVANCE S.U., THRU IMPULSE CAM SWITCH E.

E-6 PULSES 1ST PLAYER ADVANCE S.U., THRU IMPULSE CAM SWITCH D.

D-3 IN HOLD CIRCUIT TO THIS RELAY.

D-4 ENERGIZES REPLAY UNIT RESET COIL, THRU CAM SWITCH 1B.

D-3 ENERGIZES COIN RELAY.

D-3 IN HOLD CIRCUIT TO THIS RELAY.

D-5 RUNS SCORE MOTOR.

C-4 FEEDS SWITCH D ON GAME OVER RELAY AND SWITCH E ON RESET RELAY.

C-12 ENERGIZES GAME OVER RELAY (TRIP COIL), THRU BALL COUNT ZERO BREAK SWITCH.

D-3 ENERGIZES LOCK RELAY.

D-2 IN HOLD CIRCUIT TO THIS RELAY.

**OUTHOLE RELAY**

IS ENERGIZED BY OUTHOLE SWITCH, THRU SWITCH D ON LAP RELAY.

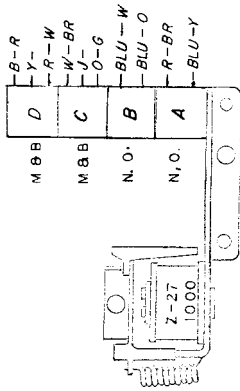

**TILT RELAY**

IS ENERGIZED BY THE TILT SWITCHES. IT IS THEN HELD IN UNTIL THE OUTHOLE RELAY PULLS IN.

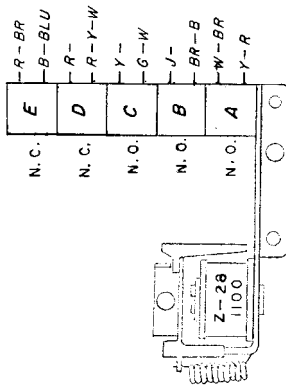

**GAME OVER RELAY**

LATCH COIL IS ENERGIZED BY THE COIN RELAY, THRU CAM SWITCH 1B. TRIP COIL IS ENERGIZED BY BALL COUNT UNIT DISC OR BY THE LOCK RELAY, ALSO BY COIN RELAY, THRU BALL COUNT UNIT ZERO BREAK SWITCH.

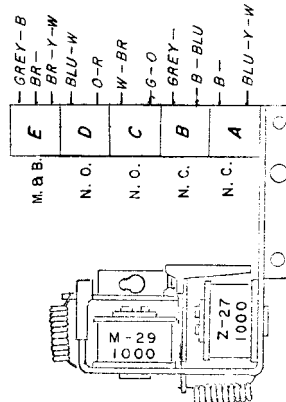

**2nd COIN RELAY**

LATCH AND TRIP COILS ARE ENERGIZED BY SWITCH D OF COIN RELAY, THRU SWITCH E OF RESET RELAY.

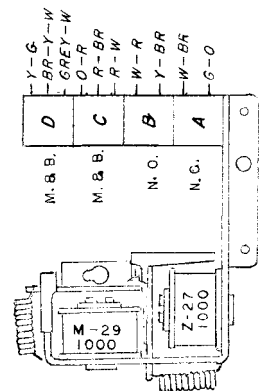

AGRAM LOCATION

**OPERATION**

BREAKS HOLD CIRCUIT TO BALL INDEX RELAY, AND MAKES IN CIRCUIT TO BALL COUNT S.U. COIL.  
 BREAKS HOLD CIRCUITS TO "TILT", "ON LEFT" AND "ON RIGHT" RELAYS. ALSO RUNS SCORE MOTOR.  
 PULSES BALL RELEASE COIL, THRU CAM SWITCH 3A.  
 IN HOLD CIRCUIT TO THIS RELAY.

IN CIRCUIT TO REPLAY UNIT S.U. COIL, THRU REPLAY---EXTRA BALL ADJUSTMENT JACK.  
 BREAKS CIRCUITS TO ALL PLAYFIELD SWITCHES.  
 TO TILT LITE.  
 ENERGIZES BALL INDEX RELAY.  
 HOLD CIRCUIT TO THIS RELAY, THRU SWITCH C ON OUTHOLE RELAY.

MAKES TO GAME OVER LITE AND NO. MATCH LITES.  
 ENERGIZES RESET RELAY, THRU SWITCH D ON COIN RELAY.  
 TO REPLAY RELAY, THRU REPLAY BUTTON SWITCH.  
 IN SERIES WITH SWITCH E ON TILT RELAY.  
 IN SERIES WITH SWITCH D ON RESET RELAY.

CHANGES "1 CAN PLAY" TO "2 CAN PLAY" LITES.  
 TO BALL COUNT S.U., THRU CAM SWITCH 1A---ALSO IN NO. MATCH CIRCUIT TO REPLAY S.U.  
 ENERGIZES PLAYER RELAY AND "A" PLAYER RELAY, THRU BALL COUNT UNIT DISC.  
 IN PARALLEL WITH SWITCH C ON GAME-OVER RELAY.

C-9  
C-13  
C-15  
D-5  
E-13  
D-13

E-12  
F-14  
B-3  
C-13  
D-15

A-2  
D-3  
E-3  
E-10  
F-10

A-3  
D-10  
E-13  
E-3

## Located On Playfield

DIAGRAM  
LOCATION

### OPERATION

#### ON RIGHT BUMPER RELAY

IS ENERGIZED BY RIGHT TOP TARGET SWITCH OR BY RIGHT TOP ROLLOVER SWITCH.

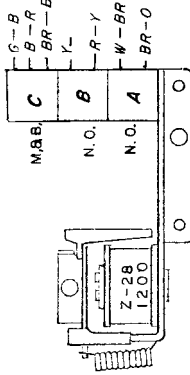

E-16 IN CIRCUIT TO 1 POINT RELAY OR ADVANCE RELAY.  
B-6 TO RIGHT JET BUMPER LITE.  
D-15 IN HOLD CIRCUIT TO THIS RELAY.

#### ON LEFT BUMPER RELAY

IS ENERGIZED BY LEFT TOP TARGET SWITCH OR LEFT TOP ROLLOVER SWITCH.

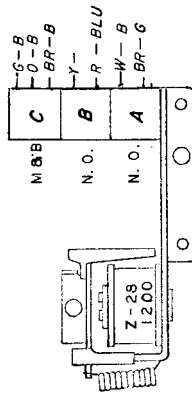

E-16 IN CIRCUIT TO 1 POINT RELAY OR ADVANCE RELAY.  
B-6 TO LEFT JET BUMPER LITE.  
D-15 IN HOLD CIRCUIT TO THIS RELAY.

#### CHANGE RELAY

IS ENERGIZED BY NO. MATCH UNIT DISC---BLU-ORANGE WIRE.

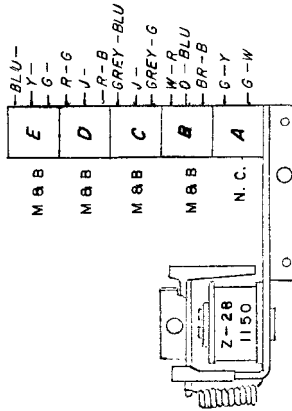

B-7 CHANGES FROM CENTER TARGET LITE TO ROLLOVER BUTTON LITES.  
B-7 CHANGES FROM LEFT BOTTOM ROLLOVER LITE TO RIGHT BOTTOM ROLLOVER LITE.  
D-18 IN CIRCUIT TO LAP RELAY, THRU LEFT OR RIGHT BOTTOM ROLLOVER SWITCH.  
E-16 IN CIRCUIT TO 10 POINT RELAY OR ADVANCE RELAY.  
D-14 ENERGIZES "5 ADVANCE RELAY", THRU CENTER TARGET SWITCH.

#### FINISH RELAY

IS ENERGIZED BY 1ST PLAYER ADVANCE UNIT E.O.S. SWITCH, THRU 1ST PLAYER ADVANCE UNIT DISC. ALSO BY 2ND PLAYER ADVANCE UNIT E.O.S. SWITCH, THRU 2ND PLAYER ADVANCE UNIT DISC.

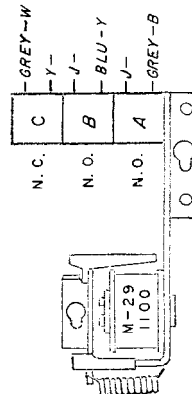

C-18 IN HOLD CIRCUIT TO LAP RELAY.  
C-7 IN SERIES WITH SWITCH B ON "A" PLAYER RELAY.  
C-7 IN SERIES WITH SWITCH C ON "A" PLAYER RELAY.

#### R-O RELAY

IS ENERGIZED BY THE LEFT ROLL-UP SWITCH.

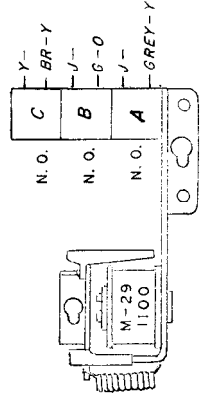

C-17 ENERGIZES 100 POINT RELAY.  
C-14 IN SERIES WITH SWITCH E ON "A" PLAYER RELAY.  
E-18 ENERGIZES LAP RELAY.

### No. 3 BUMPER RELAY

IS ENERGIZED BY THE RIGHT JET BUMPER SWITCH.

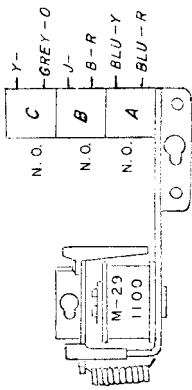

DIAGRAM  
LOCATION

C-6  
C-16  
D-20

### OPERATION

ENERGIZES RIGHT JET BUMPER.  
IN SERIES WITH SWITCH C ON "ON RIGHT BUMPER RELAY".  
IN HOLD CIRCUIT TO THIS RELAY.

### No. 2 BUMPER RELAY

IS ENERGIZED BY CENTER JET BUMPER SWITCH.

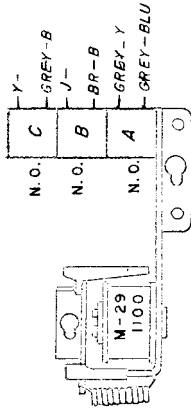

C-6  
C-16  
D-20

ENERGIZES CENTER JET BUMPER.  
PULSES ADVANCE RELAY.  
IN HOLD CIRCUIT TO THIS RELAY.

### No. 1 BUMPER RELAY

IS ENERGIZED BY LEFT JET BUMPER SWITCH.

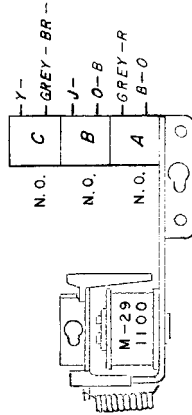

C-6  
C-16  
D-19

ENERGIZES LEFT JET BUMPER.  
IN SERIES WITH SWITCH C ON "ON LEFT BUMPER RELAY".  
IN HOLD CIRCUIT TO THIS RELAY.

### LAP RELAY

IS ENERGIZED BY THE LEFT OR RIGHT BOTTOM ROLLOVER, WHEN LIT. ALSO BY THE R-O RELAY.

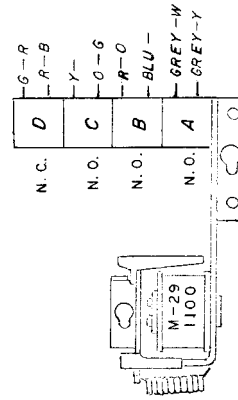

C-13  
D-5  
D-6  
E-18

PREVENTS OUTHOLE RELAY FROM ENERGIZING.  
RUNS SCORE MOTOR.  
PULSES 1ST OR 2ND PLAYER ADVANCE UNIT S.U., THRU IMPULSE CAM SWITCH B.  
IN HOLD CIRCUIT TO THIS RELAY.

### 200 RELAY

IS ENERGIZED BY CENTER PC° ROLLOVER SWITCH OR CENTER TARGET SWITCH.

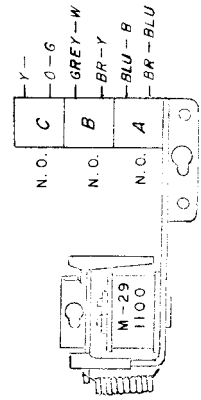

D-5  
C-16  
C-15

RUNS SCORE MOTOR.  
PULSES 100 PT. RELAY, THRU IMPULSE CAM SWITCH A.  
IN HOLD CIRCUIT TO THIS RELAY.

**5 ADVANCE RELAY**

IS ENERGIZED BY CENTER TOP ROLL-OVER, LEFT SIDE AND RIGHT SIDE TARGET SWITCHES, ALSO BY CENTER TARGET SWITCH, THRU SWITCH A ON CHANGE RELAY.

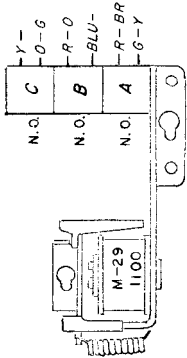

**ADVANCE RELAY**

IS ENERGIZED BY LEFT AND RIGHT TOP TARGET SWITCHES (OUTSIDE), AND BY NO. 2 BUMPER RELAY, AND BY (2) ROLL-OVER BUTTONS AND LEFT AND RIGHT JET BUMPER WHEN LIT.

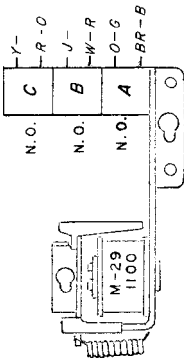

**PLAYER RELAY**

IS ENERGIZED BY SWITCH B ON 2ND COIN RELAY, THRU THE BALL COUNT UNIT DISC.

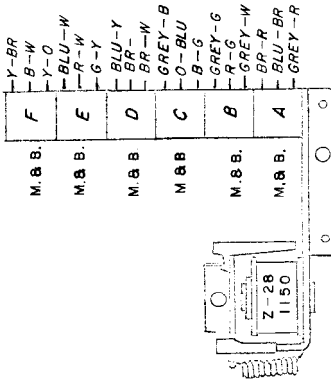

**"A" PLAYER RELAY**

SAME AS PLAYER RELAY.

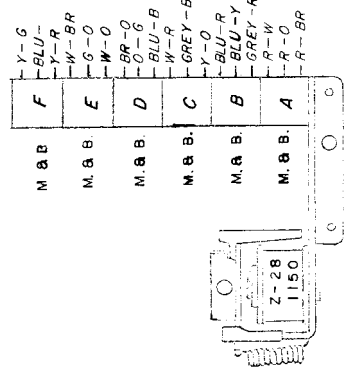

DIAGRAM LOCATION

**OPERATION**

D-5 RUNS SCORE MOTOR.  
 D-6 IN PARALLEL WITH SWITCH B ON LAP RELAY.  
 D-14 IN HOLD CIRCUIT TO THIS RELAY, THRU CAM SWITCH 5A.

D-6 ENERGIZES 1ST OR 2ND PLAYER ADVANCE UNIT S.U.  
 C-16 PULSES 10 POINT RELAY.  
 E-16 IN HOLD CIRCUIT TO THIS RELAY.

**Located in Back-Box**

D-12 IN "HI-SCORE" CIRCUITS, TO REPLAY-EXTRA BALL ADJUSTMENT JACK.  
 C-11 IN SERIES WITH SWITCH F ON THIS RELAY.  
 C-9 TO 1ST AND 2ND PLAYER 1000 PT. DRUM UNIT COILS, THRU 9TH POSITION SWS. ON 100 PT. DRUM UNITS.  
 C-8 TO 1ST AND 2ND PLAYER 100 POINT DRUM UNIT COILS.  
 C-8 TO 1ST AND 2ND PLAYER 10 POINT DRUM UNIT COILS.  
 C-8 TO 1ST AND 2ND PLAYER 1 POINT DRUM UNIT COILS.  
 E-11 IN "HI-LAP-SCORES" CIRCUITS, TO REPLAY-EXTRA BALL ADJUSTMENT JACK.  
 D-14 IN CIRCUIT TO EXTRA BALL RELAY, THRU SWITCH B ON R-O RELAY.  
 E-10 TO "EXTRA BALL" LITE AT SIDE ROLL-UP.  
 C-7 IN CIRCUIT TO 1ST AND 2ND PLAYER 10 POINT LAP DRUM UNIT COILS.  
 C-7 TO 1ST AND 2ND PLAYER 1 POINT LAP DRUM UNIT COILS.  
 E-6 IN SERIES WITH SWITCH B ON LAP RELAY.



### 1 POINT RELAY

IS ENERGIZED BY NO.1 OR NO.2 BUMPER RELAYS, AND BY STANDUP OR KICKER SWITCHES.

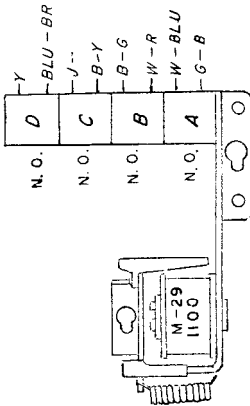
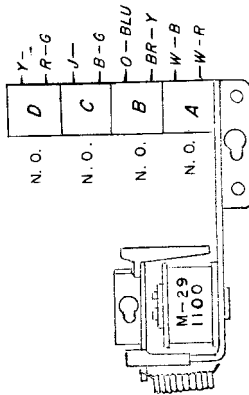

DIAGRAM  
LOCATION

C-8 IN SERIES WITH SWITCH A ON PLAYER RELAY.  
 C-20 ENERGIZES NO. MATCH S.U. COIL.  
 E-17 PULSES 10 POINT RELAY, THRU 9TH POSITION SWITCHES ON 1 PT. DRUM UNITS.  
 E-18 IN HOLD CIRCUIT TO THIS RELAY.

### 10 POINT RELAY

IS ENERGIZED BY LEFT AND RIGHT SIDE TARGETS, LEFT AND RIGHT TOP TARGETS, AND BY ADVANCE RELAY.



C-8 IN SERIES WITH SWITCH B ON PLAYER RELAY.  
 C-20 ENERGIZES LARGE BELL COIL.  
 E-18 PULSES 100 POINT RELAY, THRU 9TH POSITION SWITCHES ON 10 POINT DRUM UNITS.  
 E-18 IN HOLD CIRCUIT TO THIS RELAY.

### 100 POINT RELAY

IS ENERGIZED BY LEFT AND RIGHT TOP ROLLOVERS, LEFT AND RIGHT BOTTOM ROLLOVERS, R-O RELAY, AND 200 RELAY.

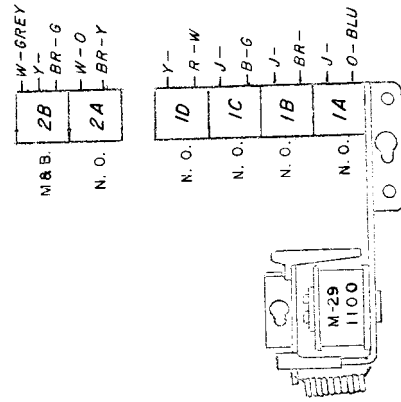

C-14 BREAKS HOLD CIRCUIT TO EXTRA BALL RELAY AND MAKES TO BALL INDEX RELAY.  
 E-18 IN HOLD CIRCUIT TO THIS RELAY.  
 C-11 IN SERIES WITH SWITCH E ON PLAYER RELAY.  
 C-20 ENERGIZES LARGE BELL COIL.  
 C-9 IN SERIES WITH SWITCH D ON PLAYER RELAY.  
 C-8 IN SERIES WITH SWITCH C ON PLAYER RELAY.

**2nd PLAYER SCORE**

**RESET RELAY**

IS ENERGIZED BY SWITCH A OF RESET RELAY, THRU IMPULSE CAN SWITCH C.

DIAGRAM  
LOCATION

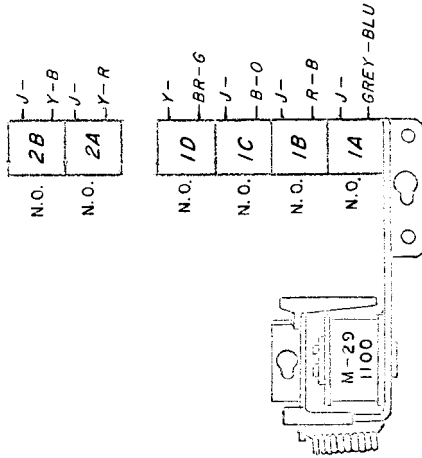

PULSES 2ND PLAYER 10 POINT LAP DRUM UNIT, THRU ZERO SWITCH.  
 PULSES 2ND PLAYER 1 POINT LAP DRUM UNIT, THRU ZERO SWITCH.  
 PULSES 2ND PLAYER 1000 POINT DRUM UNIT, THRU ZERO SWITCH.  
 PULSES 2ND PLAYER 100 POINT DRUM UNIT, THRU ZERO SWITCH.  
 PULSES 2ND PLAYER 10 POINT DRUM UNIT, THRU ZERO SWITCH.  
 PULSES 2ND PLAYER 1 POINT DRUM UNIT, THRU ZERO SWITCH.

**1st PLAYER SCORE**

**RESET RELAY**

SAME AS 2ND PLAYER SCORE RESET RELAY.

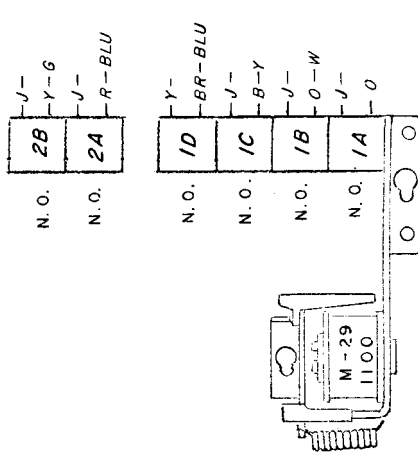

PULSES 1ST PLAYER 10 POINT LAP DRUM UNIT, THRU ZERO SWITCH.  
 PULSES 1ST PLAYER 1 POINT LAP DRUM UNIT, THRU ZERO SWITCH.  
 PULSES 1ST PLAYER 1000 POINT DRUM UNIT, THRU ZERO SWITCH.  
 PULSES 1ST PLAYER 100 POINT DRUM UNIT, THRU ZERO SWITCH.  
 PULSES 1ST PLAYER 10 POINT DRUM UNIT, THRU ZERO SWITCH.  
 PULSES 1ST PLAYER 1 POINT DRUM UNIT, THRU ZERO SWITCH.

## NOTES