

# Instruction Manual

*for*

# SPANISH EYES

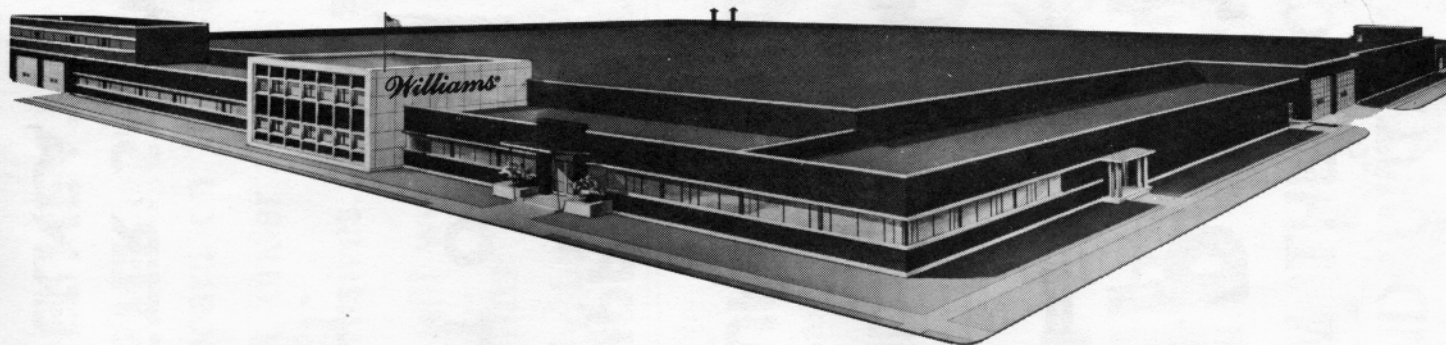

*Williams*<sup>®</sup> ELECTRONICS, INC.  
SUBSIDIARY OF THE SEEBURG CORPORATION

3401 N. California Ave.  
Phone 267-2240

Chicago, Ill. 60618, U.S.A.  
Cable Address: Wilcoin

# **IMPORTANT NOTICE**

**KINDLY INFORM LOCATIONS THAT THEY CAN TURN DISPLAY LIGHTS ON BY PRESSING LEFT FLIPPER BUTTON. MACHINE CAN STILL BE SHUT OFF BY TAPPING BOTTOM OF CABINET.**

**MASTER SWITCH (ON-OFF) IS LOCATED UNDERNEATH FRONT PART OF CABINET.**

# CAUTION!

The playboard on this machine has an improved finish with excellent wearing properties. Do not under any circumstances clean the board with water, water soap solutions or harsh abrasives. Avoid such things as steel wool, kitchen cleansers or abrasive hand soap. Water will weaken the adhering of the paint to the board and abrasives shorten the board life by many thousand plays. A wax base cleaner with negligible abrasive qualities used lightly, but frequently, will extend the board life to its full capabilities.

---

## SERVICEMAN TO REMOVE BACKGLASS:

- WITH BACK DOOR REMOVED, PULL BACK ON BRACKETS AT INSIDE TOP OF LITE BOX.
- FROM THE FRONT OF GAME, LIFT GLASS UP AND OUT.

# ALTERNATOR UNIT

LOCATED ON MECHANISM PANEL.

USED IN CONJUNCTION WITH 5¢ RELAY FOR "2 COINS - 1 PLAY" FEATURE.

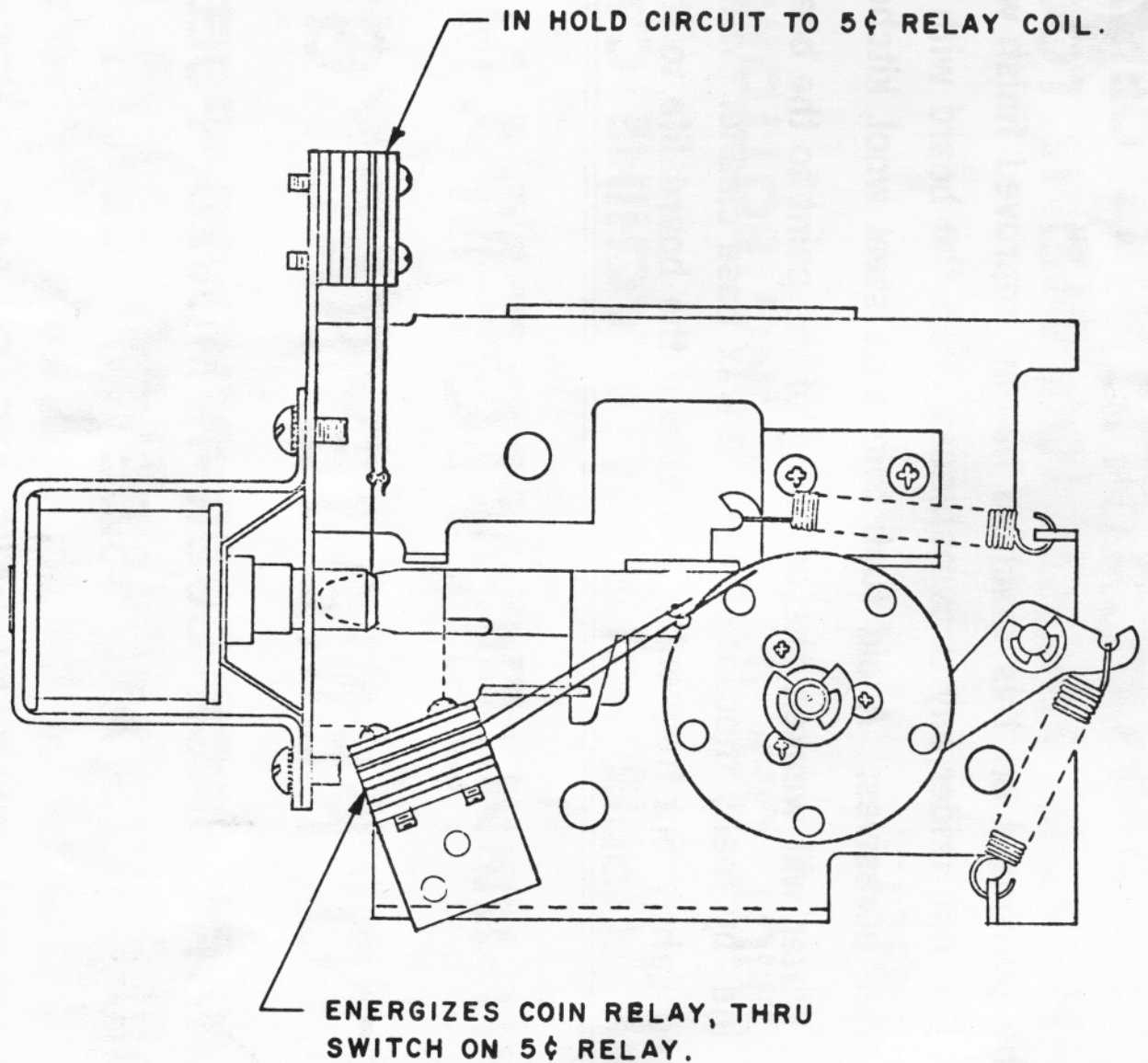

# INSTRUCTIONS FOR COIN TRIP SWITCH ADJUSTMENT

WIRE SHOULD BE IN CONTACT WITH END OF CRESCENT OPENING WHEN BLADE ADJUSTMENT IS MADE.

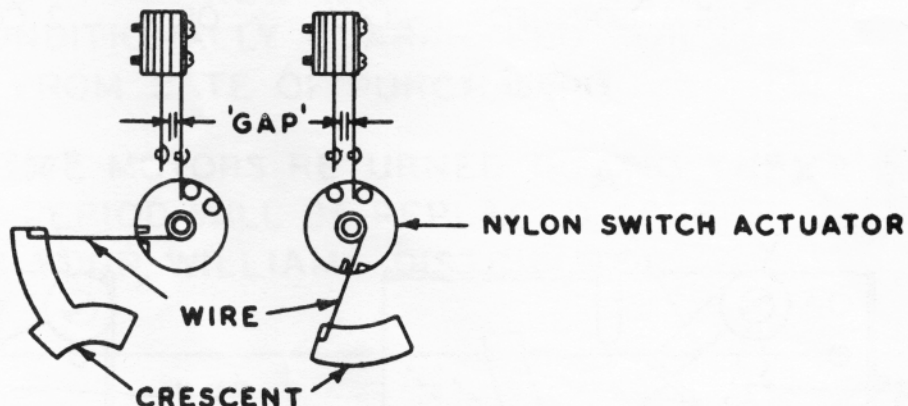

Long blade should be in contact with nylon switch actuator and have a maximum overtravel of 1/32.

or

Using a gram gauge, tension of long blade should not exceed 10 grams.

## SWITCH ADJUSTMENT

1. For small coins, such as dimes, adjust short blade so that the 'gap' between the silver contacts is .045 to .055.
2. For larger & heavier coins the 'gap' should be .045 to .060.
3. Do not adjust 'gap' closer than .040.

## POWER TRANSFORMER:

LOCATED ON MECHANISM PANEL, IT IS EQUIPPED WITH A SECONDARY TAP. IF YOUR GAME IS ON LOCATION WITH EXTREMELY LOW LINE VOLTAGE, REMOVE LEAD FROM LUG MARKED 24 VOLTS AND SOLDER TO ALTERNATE LUG MARKED "HIGH". THIS WILL BOOST SECONDARY VOLTAGE APPROXIMATELY 2-3 VOLTS.

## LEG LEVELERS:

ARE PROVIDED FOR TWO PURPOSES - 1ST TO LEVEL GAME ON LOCATION, 2ND TO INCREASE PITCH FOR GAME PERCENTAGING. IF IT IS DESIRED TO SPEED UP PLAY AND DECREASE SCORES, RAISE REAR LEG LEVELERS TO INCREASE PITCH.

# INSTRUCTIONS FOR ALTERING COIN CHUTES EQUIPPED WITH A FLIP-OVER DEVICE.

FOR 1 COIN - FOR 1 PLAY

OR

2 COINS - FOR 1 PLAY

**FIGURE 1**

**FIGURE 2**

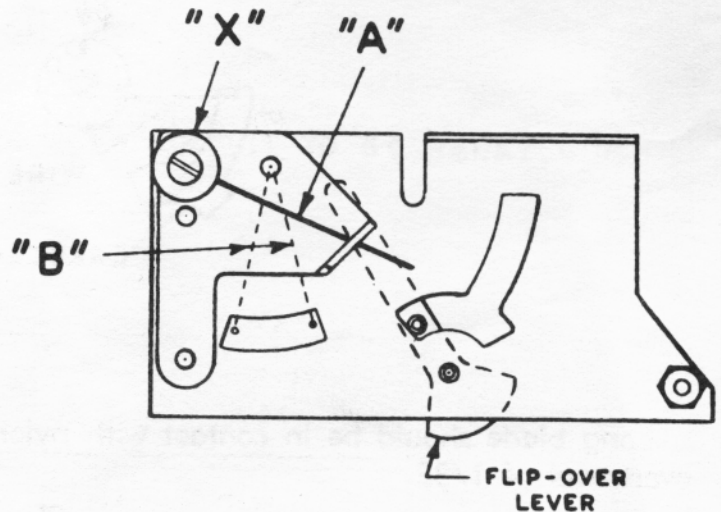
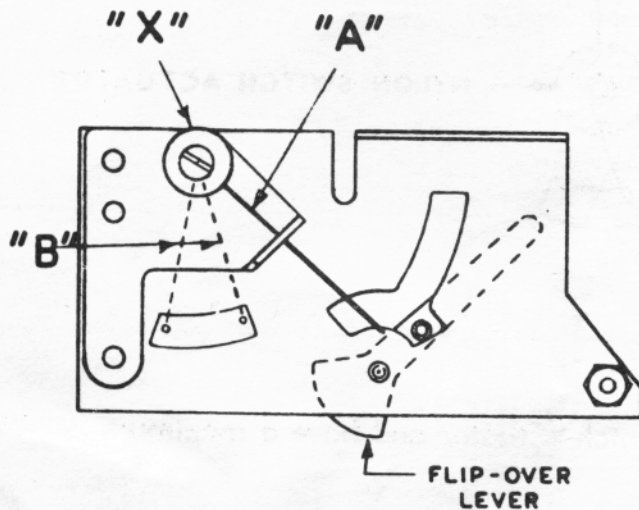

## **1 COIN - FOR 1 PLAY (FIGURE 1):**

Wire form "A" should be in position as shown in Figure 1. Flip-over lever should rebound from wire form "A" and return to position shown in Figure 1 everytime a coin is inserted. All coins pass over the coin trip switch wire "B".

## **2 COINS - FOR 1 PLAY (FIGURE 2):**

Wire form "A" should be in position as shown in Figure 2 (see note). Flip-over lever should alternate from side to side. 1st coin should go to cash box without actuating coin trip switch wire "B", 2nd coin should pass the coin trip switch wire "B" and returns flip-over to position as shown in Figure 2.

## **NOTE:**

To change from 1 coin play to 2 coin play or vice versa - loosen screw "X" and move screw, bushing & wire form "A" to position as required - shown in Figure 1 position as required - shown in Figure 1 or Figure 2.

When using 1 coin for 1 play, wire form "A" should not under any circumstances be allowed to enter the "Banana" slot and cause binding of flip-over lever.

# WARRANTY

THE MOTORS IN ALL NEW WILLIAMS PRODUCTS ARE UN-CONDITIONALLY GUARANTEED FOR 6 MONTHS FROM DATE OF PURCHASE.

ANY DEFECTIVE MOTORS RETURNED DURING THE WARRANTY PERIOD WILL BE REPLACED FREE OF CHARGE BY YOUR WILLIAMS DISTRIBUTOR.

## IMPORTANT NOTICE

WHEN ORDERING PARTS ALWAYS SPECIFY NAME OF UNIT, GAME AND SERIAL NUMBER, IN ADDITION TO A CLEAR DESCRIPTION OF THE PART AND PART NUMBER IF POSSIBLE.

### UNIT PARTS LIST

UNIT NAME	CONTACT DISC	WIPER ASSEMBLY	RATCHET GEAR ASSEMBLY	MOTORS
REPLAY	-----	-----	A-6400	
BALL COUNT	C-6414	B-7456-3	A-6402-10	SCORE MOTOR
NO. MATCH	C-6414	B-7456-2	A-6401	14A-7883 (60 CYCLE)
TENS	A-7195	A-6294	3C-7272	14A-7884 (50 CYCLE)
HUNDREDS	-----	-----	3C-7272	
THOUSANDS	-----	-----	3C-7272	
10 THOUSANDS	A-7195	A-6294	3C-7272	

TO MAKE GAME MORE "CONSERVATIVE" OR "LIBERAL" — MOVE POST 3/16" AS SHOWN IN SKETCH BELOW. SPOTTING HOLES ARE PROVIDED AND CAN BE SEEN ON REMOVAL OF POSTS.

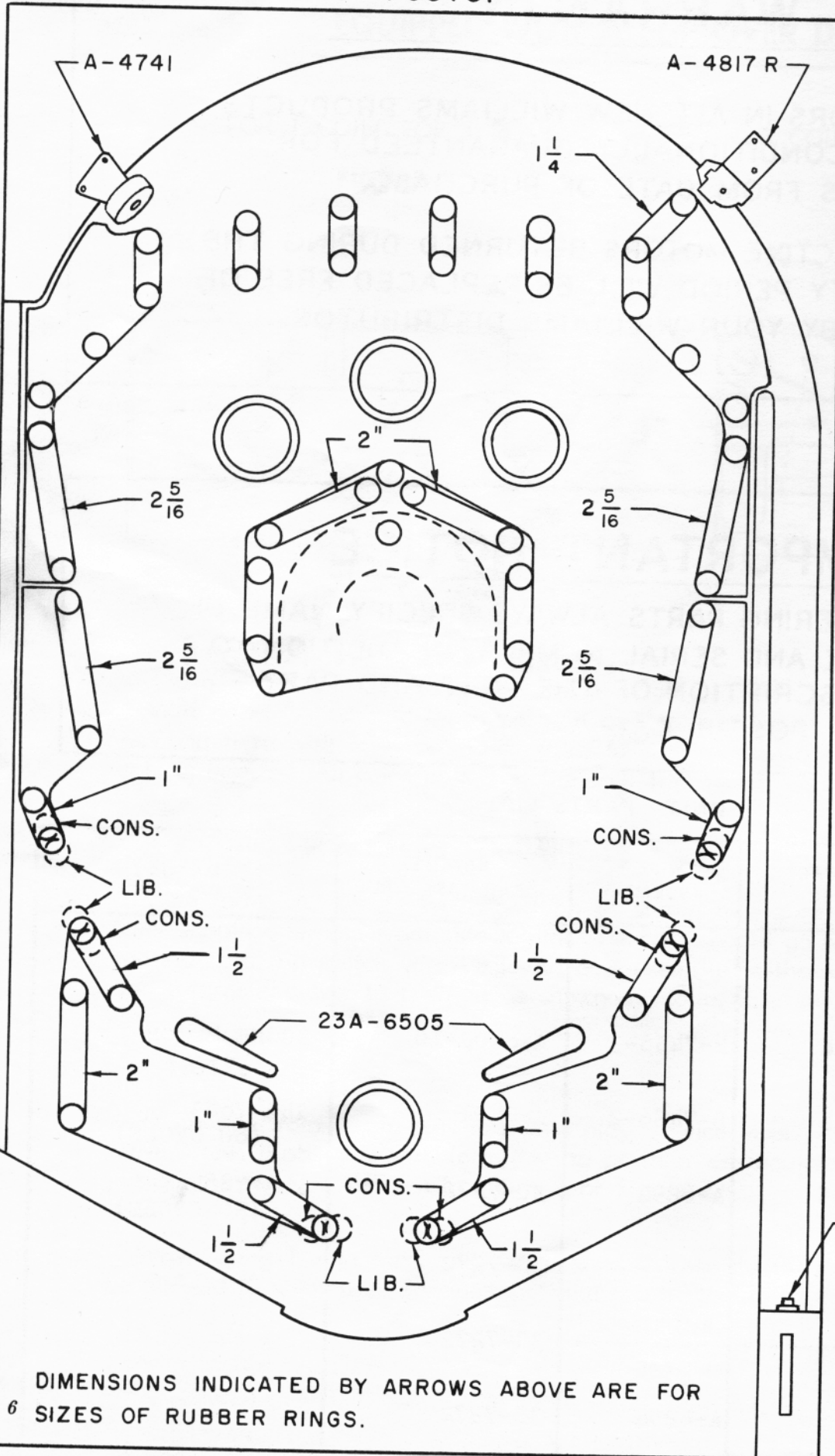

ABBREVIATIONS:

CONS.—CONSERVATIVE  
LIB.—LIBERAL

RUBBER RING NUMBERS:

23A-6300	5/16" I.D.
23A-6302	1" I.D.
23A-6303	1 1/4" I.D.
23A-6304	1 1/2" I.D.
23A-6305	2" I.D.
23A-6306	2 5/16" I.D.
23A-6505	1 1/2" I.D.

A-4741 REBOUND ASS'Y.  
A-4817 R BALL GATE ASS'Y.

23A-6327 BALL SHOOTER  
RUBBER TIP

DIMENSIONS INDICATED BY ARROWS ABOVE ARE FOR  
6 SIZES OF RUBBER RINGS.



"SPANISH EYES" COIL CHART

THIS GAME OPERATES ON 24 VOLTS. WHEN ORDERING REPLACEMENT TRANSFORMERS, MOTORS, COILS OR METERS .... MAKE SURE TO SPECIFY CORRECT PART NUMBER.

<u>NUMBER</u>	<u>DESCRIPTION</u>	<u>LOCATION</u>
14 A-7883	SCORE MOTOR - 60 CYCLE	MECH. PANEL
14 A-7884	SCORE MOTOR - 50 CYCLE	MECH. PANEL
15 A-6771	TRANSFORMER - 60 CYCLE	MECH. PANEL
15 A-6782-1	TRANSFORMER - 50 CYCLE	MECH. PANEL
B 6396	24 VOLT METER	MECH. PANEL
<u>SOLENOID COILS</u>		
A 22-550	MATCH UNIT STEP UP BALL COUNT UNIT STEP UP BALL RELEASE	INSERT INSERT PLAYFIELD
A 23-600	REPLAY UNIT STEP UP	INSERT
A2-23-750	KNOCKER	CABINET
B 26-800	ALTERNATOR UNIT BALL COUNT UNIT RESET SCORE DRUM UNITS ... (4 req'd.) REPLAY UNIT RESET	MECH. PANEL INSERT INSERT INSERT
C 2-26-800	CHIME	INSERT
D1-24-1400	RELAY BANK RESET ... (2 req'd.)	PLAYFIELD
G 23-750	EJECT COIL JET BUMPERS ... (4 req'd.)	PLAYFIELD PLAYFIELD
FL 21-375/ 28-400	FLIPPERS ... (2 req'd.)	PLAYFIELD
<u>RELAY COILS</u>		
M 1-31-1500	COIN LOCKOUT	DOOR
M 29-1000	GAME TRIP GAME OVER TRIP	MECH. PANEL MECH. PANEL
M 29-1100	5¢ RELAY 10 ¢ RELAY 25 ¢ RELAY 10 POINT RELAY 100 POINT RELAY 1,000 POINT RELAY 'A' TO 'E' RELAY '1' TO '6' RELAY 5,000 RELAY SCORE RESET RELAY	MECH. PANEL MECH. PANEL MECH. PANEL INSERT INSERT INSERT INSERT PLAYFIELD PLAYFIELD PLAYFIELD INSERT
M 30-1300	100,000 POINT RELAY	INSERT
S 27-500	RELAY BANK ... (11 req'd.)	PLAYFIELD
Z 27-1000	GAME LATCH EJECT RELAY COIN RELAY OUTHOLE RELAY RESET RELAY GAME OVER LATCH	MECH. PANEL MECH. PANEL MECH. PANEL MECH. PANEL MECH. PANEL MECH. PANEL
Z 28-1150	BALL INDEX RELAY	MECH. PANEL
Z 29-1250	LOCK RELAY	MECH. PANEL
XM 27-675	METER COIL	B 6396
Z 28-1200	ON BUMPER RELAY	PLAYFIELD

# ADJUSTMENTS ON MECHANISM PANEL

## 5¢ Adjustment

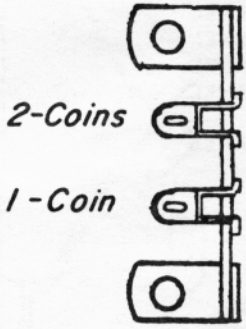

IN "2 COINS FOR 1 PLAY", CIRCUIT TO COIN RELAY PASSES THRU SWITCH ON ALTERNATOR UNIT.

## 10¢ Adjustment

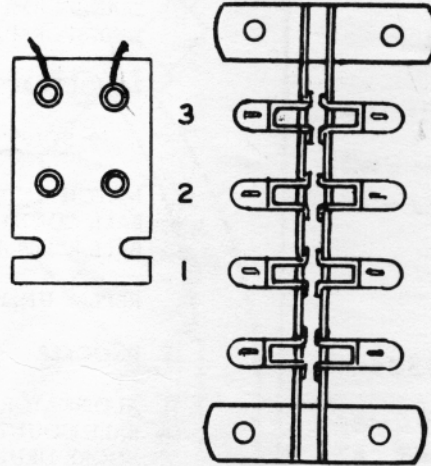

PROVIDES 1, 2 OR 3 PLAYS FOR ONE COIN.

## 25¢ Adjustment

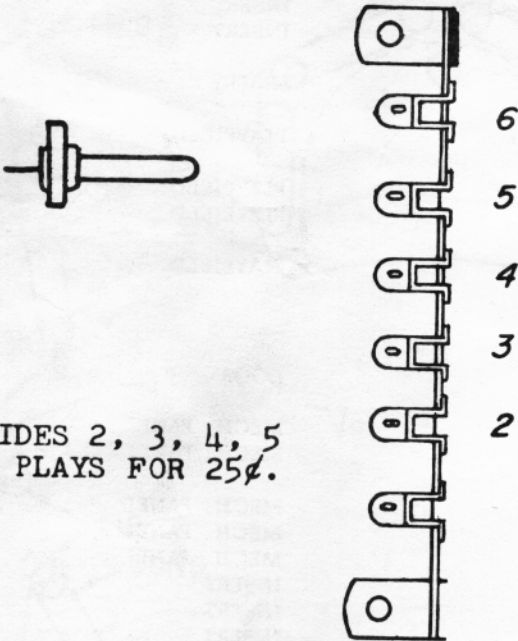

PROVIDES 2, 3, 4, 5 OR 6 PLAYS FOR 25¢.

## Motor Service Jack

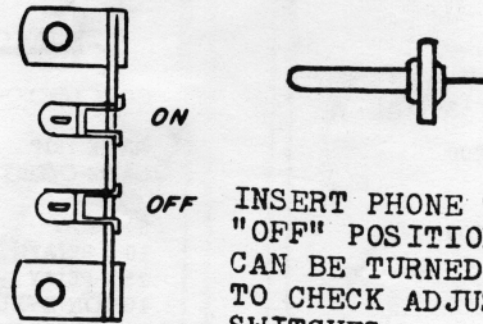

INSERT PHONE TIP IN "OFF" POSITION - CAMS CAN BE TURNED BY HAND TO CHECK ADJUSTMENT OF SWITCHES.

## SUGGESTED SCORE CARDS:

- 5 BALL PLAY-----408-13
- 3 BALL PLAY-----408-5

## MASTER ON-OFF SW.

(Located under front of Cabinet)

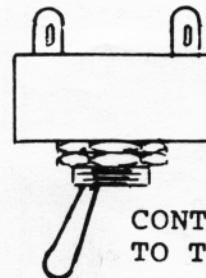

CONTROLS POWER TO TRANSFORMER

Hi-Score Adjustment

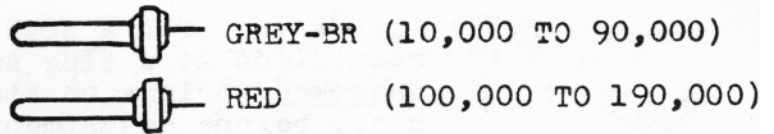
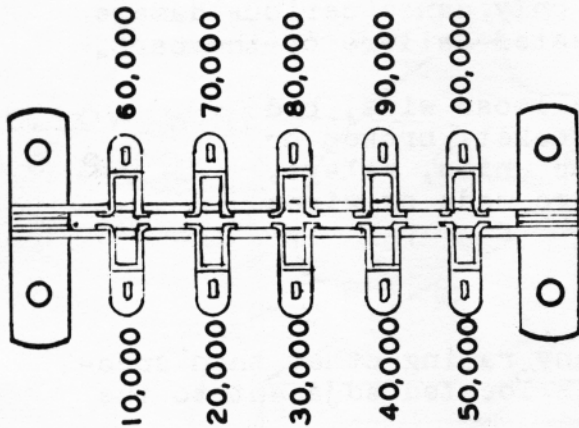

INSERT PLUGS INTO 10 POINT FEMALE AT DESIRED POSITIONS.

EXAMPLES:

- GREY-BR INTO 30,000 SCORES AT 30,000.
- RED INTO 00,000 SCORES AT 100,000.
- RED INTO 30,000 SCORES AT 130,000.
- RED INTO 90,000 SCORES AT 190,000.

NO. MATCH ADJ.

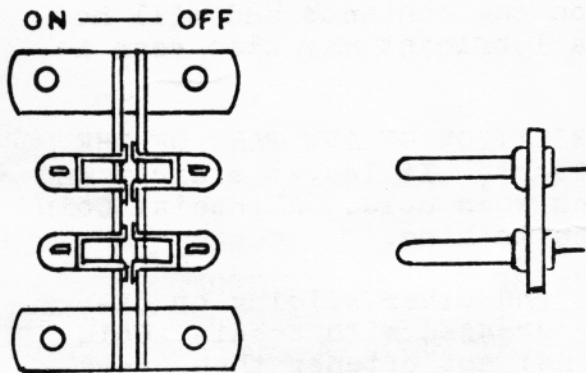

IN "ON" POSITION, A NUMBER MATCH LITE WILL APPEAR WHEN GAME IS OVER. TO AWARD REPLAYS, WHEN NUMBER IS MATCHED, "REPLAY-ADD A BALL-NOVELTY" ADJUSTMENT MUST BE IN REPLAY POSITION. IF IT IS IN "ADD A BALL" POSITION, NUMBER MATCH ADJUSTMENT MUST BE TURNED TO "OFF".

No. of Balls Adjustment

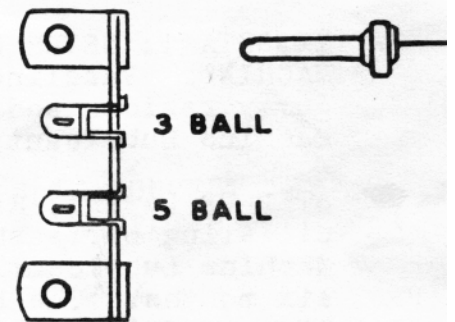

Plug changes 3 to 5 ball play or vice versa.

GAME ADJUSTMENT

IN REPLAY POSITION, HI-SCORES AND NUMBER MATCH WILL ADVANCE REPLAY UNIT, WHILE "1 TO 6 RESET RELAY" AND "A TO E RESET RELAY" ADVANCE BALL COUNT UNIT.

IN ADD-A-BALL POSITION, HI-SCORES, "1 TO 6 RESET RELAY" AND "A TO E RESET RELAY" WILL ADVANCE BALL COUNT UNIT. NUMBER MATCH ADJUSTMENT SHOULD BE "OFF".

IN NOVELTY PLAY, "1 TO 6 RESET RELAY" AND "A TO E RESET RELAY" WILL ADVANCE 10,000 POINT DRUM UNIT.

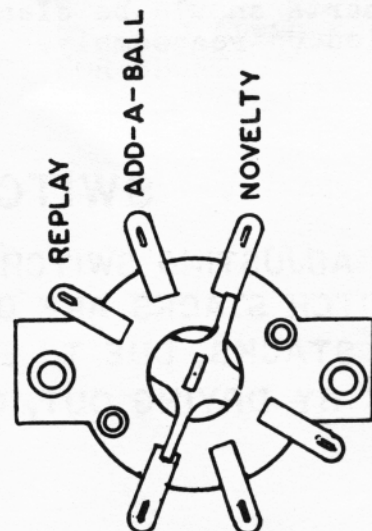

## 1. GENERAL

NEVER EXPERIMENT with any of the mechanism. Locate any trouble with the aid of Wiring Diagrams or Operating & Servicing Information supplied with the machine, then check for proper adjustment of the units involved before making any changes. Improper adjustment or make-shift repair will only cause serious damage to other parts of the machine or repeated failure of the part.

NOTE: Always look for a possible loose wire, bad connection at a plug and socket, broken or unhooked springs on step-up units, relays, etc., before adjustments are made or wires reconnected.

## 2. FUSES

IMPORTANT: Never replace fuses with any rating other than specified on the fuse block; this block is located adjacent to the transformer.

## 3. LUBRICATION

Over-lubrication causes far more trouble in coin operated equipment than under-lubrication. Practically all cases of poor contact on switches and wiper discs are due to oil or grease, or oil vapor, which forms a film or residue on the contacts and will not allow current to pass through. Excess lubricant may also seep into clutches causing them to slip.

IMPORTANT: NEVER USE VASELINE FOR LUBRICATION OF ANY PART OF THE MACHINE. Vaseline is not a true lubricant. It leaves a dirty and gummy residue and it becomes very thick when cold. A special Coin Machine Lubricant is supplied with each machine.

STEP-UP Levers, Ratchets, Cams, Shafts and other sliding or oscillating parts should be very lightly greased with special Coin Machine Lubricant (supplied with machine) not oftener than every six months. The bakelite discs (biscuits) on the Motor Units and Step-up Units will require lubrication with the special Coin Machine Lubricant only after the grease is completely evaporated (3 to 12 months, depending on climate) or when the film of grease becomes dirty. In either event, clean the parts thoroughly with a solvent, then apply an extremely thin coat of the special grease.

Solenoid Plungers should not have a lubricant of any kind. Should there be a sluggish tendency or if plungers are sticking, the parts should be cleaned with a solvent and flaked graphite applied on reassembly.

## SWITCH ADJUSTMENT

BEFORE ADJUSTING SWITCHES, MAKE CERTAIN THE SCREWS HOLDING THE SWITCH STACKS ARE DOWN TIGHTLY. BAKELITE SPACERS IN THE SWITCH STACKS, DUE TO EXCESSIVE MOISTURE, HAVE OCCASIONALLY SHRUNK BY DRYING OUT, CAUSING POOR ADJUSTMENT.

# SILICON BRIDGE RECTIFIER

PART NO. 5A-8741

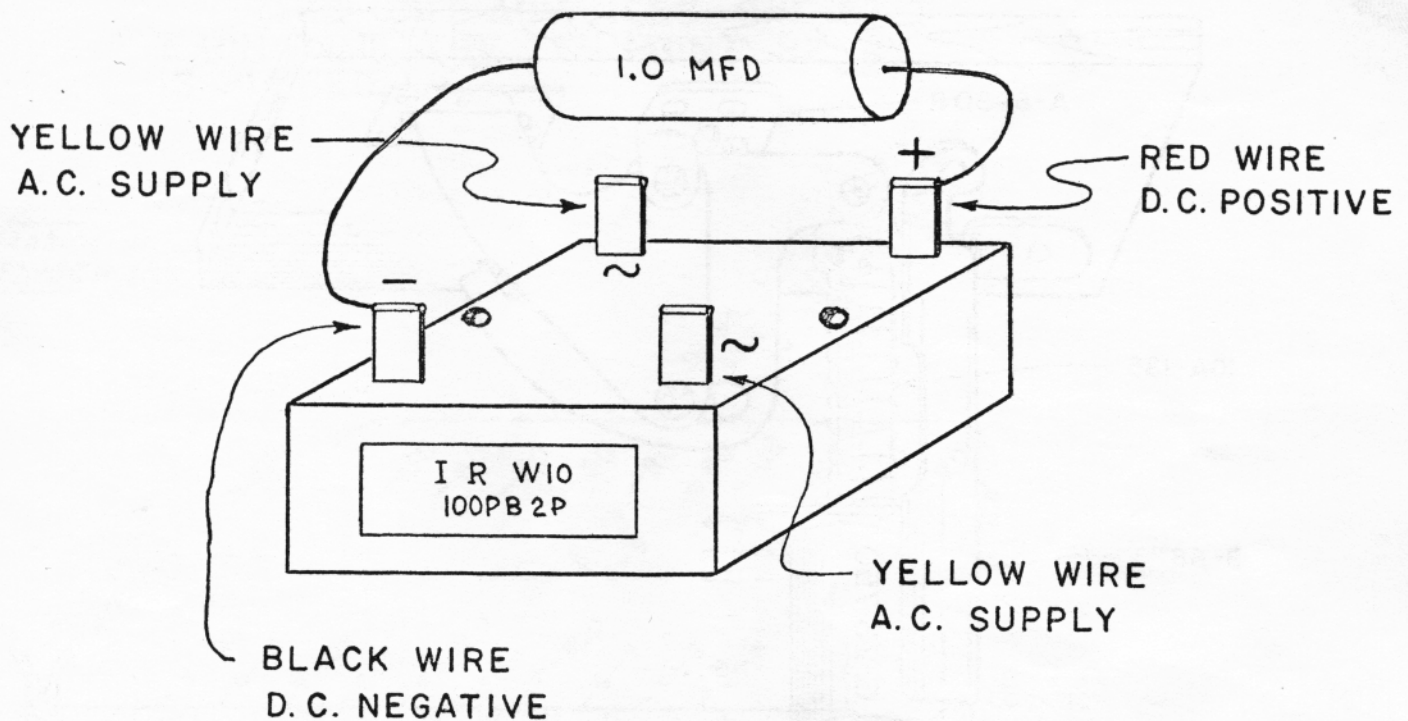

THE FUNCTION OF THE RECTIFIER AND CAPACITOR IS TO CONVERT THE ALTERNATING CURRENT (A.C.) TO DIRECT CURRENT (D.C.), SUPPLYING D.C. TO THE BUMPERS, KICKERS ETC.

THE BRIDGE RECTIFIER SHOULD PRACTICALLY NEVER NEED REPLACING, AS IT IS RATED WELL OVER THE VOLTAGE AND CURRENT REQUIREMENTS OF THE COMPONENTS IT SUPPLIES.

IF, HOWEVER, THE 15 AMP 24 VOLT FUSE ON THE MECHANISM PANEL OPENS, IT COULD BE DUE TO A FAULTY RECTIFIER. DISCONNECT THE A.C. INPUT TO RECTIFIER, REPLACE FUSE, AND RECHECK.

IF THE 10 AMP FUSE LOCATED NEXT TO THE RECTIFIER OPENS, CHECK ALL D.C. COMPONENTS I.E. BUMPERS; KICKERS ETC. FOR SHORTS.

# BALL EJECT CAM UNIT

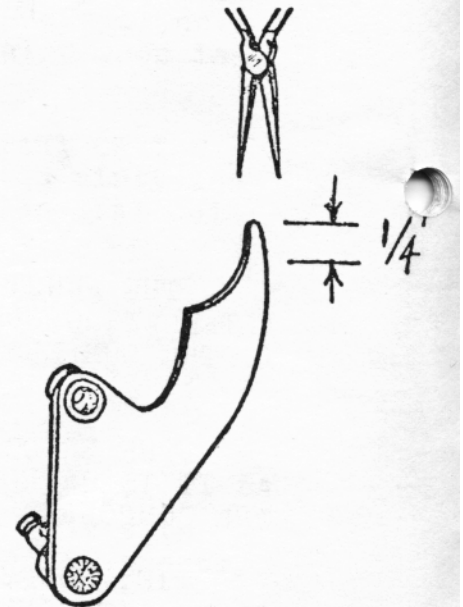
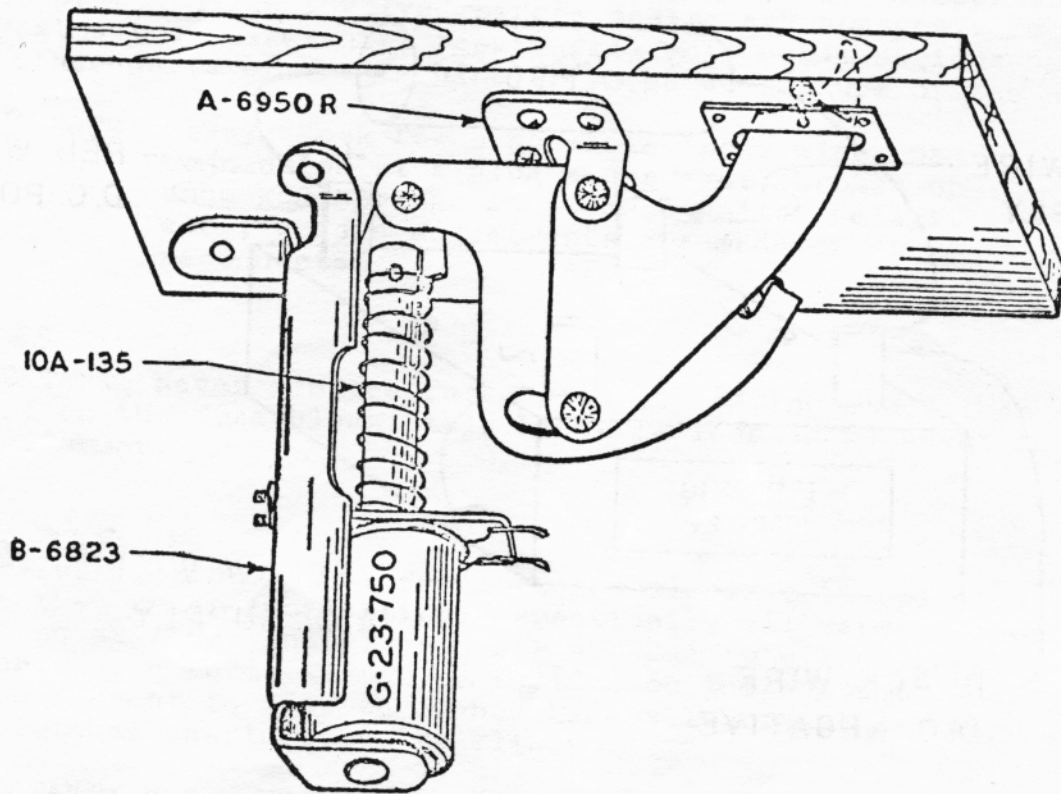

TO CHANGE DIRECTION OF BALL,  
WHEN EJECTED, GRASP "BALL EJECT CAM"  
WITH LONG-NOSED PLIERS (APPROXIMATELY  
1/4") AND BEND SLIGHTLY.  
BENDING TO THE LEFT WILL CHANGE  
DIRECTION OF EJECTED BALL SLIGHTLY  
TO THE RIGHT, AND VICE-VERSA.

**CAUTION**  
IF BEND IS TOO GREAT, IT MAY  
CAUSE A BIND WHEN "BALL EJECT CAM"  
IS RESTING IN PART #3A-6015G-6.

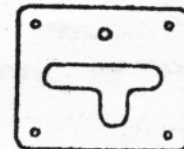

3A-6015G-6

# No. MATCH UNIT

THIS UNIT ADVANCES ONE STEP EACH TIME THE TEN POINT RELAY IS PULSED.

View looking at  
WIPER FINGER side

IN NO. MATCH CIRCUIT,  
THESE WIRES COME FROM  
10 PT. D.U. DISC.

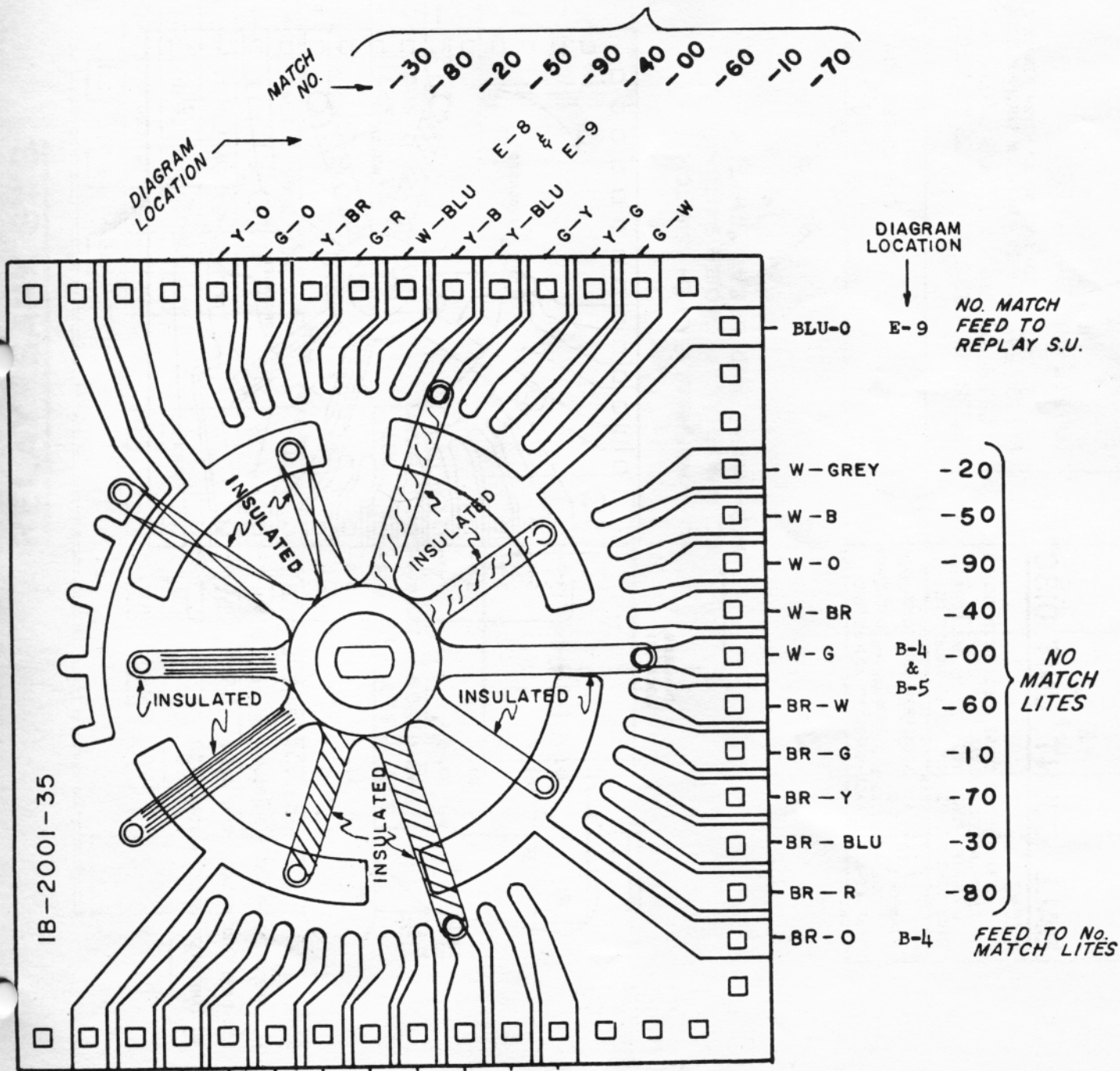

# BALL COUNT UNIT DISC

VIEW LOOKING AT WIPER FINGER SIDE  
WITH WIPERS IN ZERO POSITION.

DURING RESET CYCLE, THIS UNIT RESETS  
TO ZERO AND THEN ADVANCES 5 STEPS.

DURING PLAY, IT ADVANCES ONE STEP  
EACH TIME THE "1 TO 6 RESET RELAY" OR  
"A TO E RESET RELAY" IS ENERGIZED.

IT ALSO ADVANCES WHEN INDICATED  
HI-SCORE IS MADE.

THESE CIRCUITS PASS THRU THE  
"REPLAY-ADD A BALL-NOVELTY" ADJUSTMENT  
JACK.

TO FILT LIFE.  
TO GAME OVER LIFE.

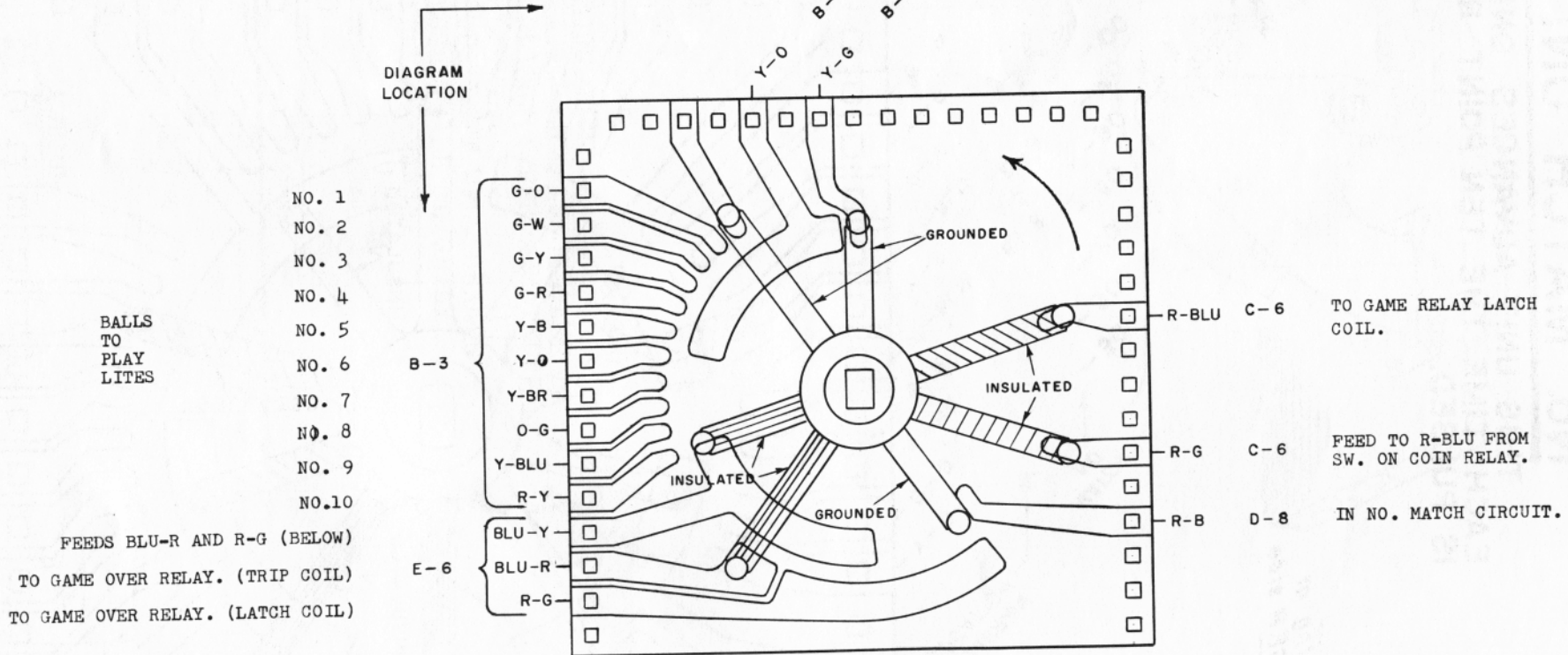

BALLS  
TO  
PLAY  
LITES

FEEDS BLU-R AND R-G (BELOW)  
TO GAME OVER RELAY. (TRIP COIL)  
TO GAME OVER RELAY. (LATCH COIL)



# RELAY BANK SWS.

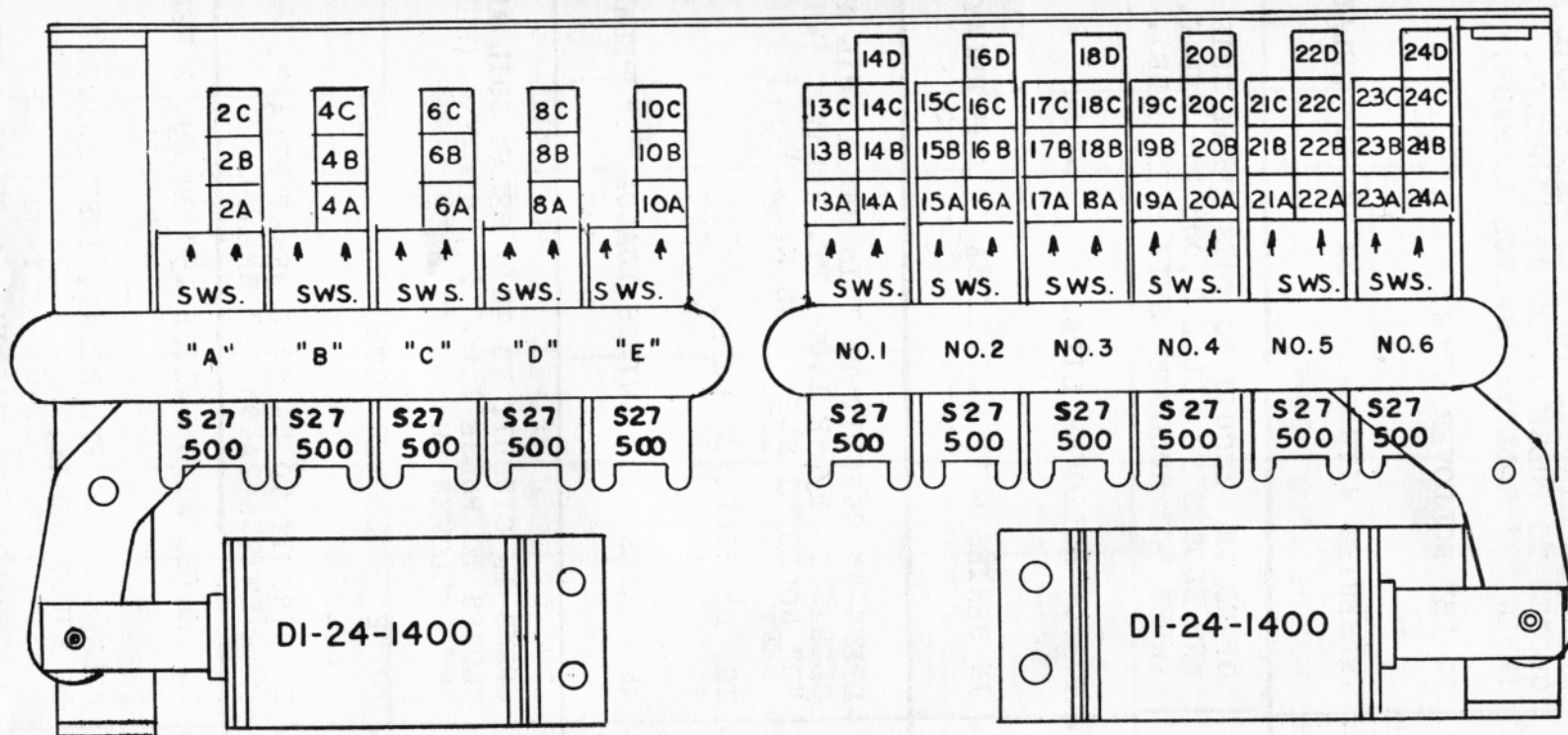

N.O. — NORMALLY OPEN SWITCH  
 N.C. — NORMALLY CLOSED SWITCH  
 M&B — MAKE AND BREAK SWITCH

RELAY	SW.	WIRE COLORS	DIAGRAM LOCATION	TYPE	SWITCH OPERATION
"A" RELAY	2C	-J- R-BLU BR-Y	E-10	M&B	OPENS IN CIRCUIT TO THIS RELAY COIL AND CLOSSES TO PULSE 1,000 POINT RELAY. (WHEN "A" ROLLOVER SWITCH IS MADE.)
	2B	0-W -Y-	B-6	N.O.	TO "A" ROLLOVER LITE.
	2A	-J- -Y-	C-12	N.O.	IN SERIES WITH SWITCH 4A ON "B" RELAY.

RELAY	SW.	WIRE COLORS	DIAGRAM LOCATION	TYPE	SWITCH OPERATION
"B" RELAY	4C	-J- R-Y BR-Y	E-10	M&B	OPENS IN CIRCUIT TO THIS RELAY COIL AND CLOSSES TO PULSE 1,000 POINT RELAY. (WHEN "B" ROLLOVER SWITCH IS MADE.)
	4B	O-B -Y-	B-6	N.O.	TO "B" ROLLOVER LITE.
	4A	-J- -J-	C-12	N.O.	IN SERIES WITH SWITCH 6A ON "C" RELAY.
"C" RELAY	6C	-J- R-G BR-Y	E-10	M&B	OPENS IN CIRCUIT TO THIS RELAY COIL AND CLOSSES TO PULSE 1,000 PT. RELAY. (WHEN "C" ROLLOVER SWITCH IS MADE.)
	6B	B-R -Y-	B6	N.O.	TO "C" ROLLOVER LITE.
	6A	-J- -J-	D-12	N.O.	IN SERIES WITH SWITCH 8A ON "D" RELAY.
"D" RELAY	8C	-J- R-BR BR-Y	E-10	M&B	OPENS IN CIRCUIT TO THIS RELAY COIL AND CLOSSES TO PULSE 1,000 PT. RELAY. (WHEN "D" ROLLOVER SWITCH IS MADE.)
	8B	B-BLU -Y-	B-6	N.O.	TO "D" ROLLOVER LITE.
	8A	-J- -J-	D-12	N.O.	IN SERIES WITH SWITCH 10A ON "E" RELAY.
"E" RELAY	10C	-J- R-O BR-Y	E-11	M&B	OPENS IN CIRCUIT TO THIS RELAY COIL AND CLOSSES TO PULSE 1,000 PT. RELAY. (WHEN "E" ROLLOVER SWITCH IS MADE.)
	10B	B-G -Y-	B-6	N.O.	TO "E" ROLLOVER LITE.
	10A	-J- Y-G	E-12	N.O.	IN CIRCUIT TO "A TO E RESET RELAY". (SEE SWITCH 2A ON "A" RELAY).
NO. 1 RELAY	13C	BR-R -J-	C-13	N.C.	IN SERIES WITH SWITCH 15C ON NO. 2 RELAY
	13B	W-G O-W	D-13	N.O.	PULSES 1,000 PT. RELAY, THRU SWITCH D ON EJECT RELAY.
	13A	-J- -Y-	B-7	N.O.	IN SERIES WITH SWITCH 15A ON NO.2 RELAY.

RELAY	SW.	WIRE COLORS	DIAGRAM LOCATION	TYPE	SWITCH OPERATION
	14D	BR-Y G-Y -J-	C-12	M&B	OPENS IN CIRCUIT TO 1,000 PT. RELAY AND CLOSES IN SERIES CIRCUIT TO 5,000 PT. RELAY.
	14C	Y-O G-R -J-	C-12	M&B	OPENS IN CIRCUIT TO 5,000 RELAY, THRU HOOP ROLLOVER SWITCH, AND CLOSES IN SERIES CIRCUIT TO "1 TO 6 RESET RELAY".
	14B	-J- R-B	E-11	N.C.	TO THIS RELAY COIL, THRU NO. 1 TARGET SWITCH.
	14A	GRAY-R -Y-	B-7	N.O.	TO NO. 1 TARGET LITES.
NO. 2 RELAY	15C	-J- -J-	D-13	N.C.	IN SERIES WITH SWITCH 17C ON NO. 3 RELAY.
	15B	W-BR O-W	D-13	N.O.	PULSES 1,000 PT. RELAY, THRU SWITCH D ON EJECT RELAY.
	15A	-J- -J-	B-7	N.O.	IN SERIES WITH SWITCH 17A ON NO. 3 RELAY.
	16D	BR-Y -J- -J-	D-12	M&B	OPENS IN CIRCUIT TO 1,000 POINT RELAY AND CLOSES IN SERIES CIRCUIT TO 5,000 RELAY.
	16C	Y-O -J- -J-	D-12	M&B	OPENS IN CIRCUIT TO 5,000 RELAY, THRU HOOP ROLLOVER SWITCH, AND CLOSES IN SERIES CIRCUIT TO "1 TO 6 RESET RELAY".
	16B	-J- BLU-Y	E-11	N.C.	TO THIS RELAY COIL, THRU NO. 2 TARGET SWITCH.
	16A	GRAY-BLU -Y-	B-7	N.O.	TO NO. 2 TARGET LITES.
NO. 3 RELAY	17C	-J- -J-	D-13	N.C.	IN SERIES WITH SWITCH 19C ON NO. 4 RELAY.
	17B	W-GRAY O-W	D-13	N.O.	PULSES 1,000 POINT RELAY, THRU SWITCH D ON EJECT RELAY.
	17A	-J- -J-	B-7	N.O.	IN SERIES WITH SWITCH 19A ON NO. 4 RELAY.
	18D	BR-Y -J- -J-	D-12	M&B	OPENS IN CIRCUIT TO 1,000 RELAY AND CLOSES IN SERIES CIRCUIT TO 5,000 RELAY.
	18C	Y-O -J- -J-	D-12	M&B	OPENS IN CIRCUIT TO 5,000 RELAY, THRU HOOP ROLLOVER SWITCH, AND CLOSES IN SERIES CIRCUIT TO "1 TO 6 RESET RELAY".

RELAY	SW.	WIRE COLORS	DIAGRAM LOCATION	TYPE	SWITCH OPERATION
	18B	-J- BLU-W	E-11	N.C.	TO THIS RELAY COIL, THRU NO. 3 TARGET SWITCH.
	18A	GRAY-Y -Y-	B-7	N.O.	TO NO. 3 TARGET LITES.
NO. 4 RELAY	19C	-J- -J-	D-13	N.C.	IN SERIES WITH SWITCH 21C ON NO. 5 RELAY.
	19B	BR-BLU O-W	D-13	N.O.	PULSES 1,000 POINT RELAY, THRU SWITCH D ON EJECT RELAY.
	19A	-J- -J-	B-7	N.O.	IN SERIES WITH SWITCH 21A ON NO. 5 RELAY.
	20D	BR-Y -J- -J-	D-12	M&B	OPENS CIRCUIT TO 1,000 RELAY AND CLOSSES IN SERIES CIRCUIT TO 5,000 RELAY.
	20C	Y-O -J- -J-	D-12	M&B	OPENS IN CIRCUIT TO 5,000 RELAY, THRU HOOP ROLLOVER SWITCH, AND CLOSSES IN SERIES CIRCUIT TO "1 TO 6 RESET RELAY.
	20B	-J- BLU-O	E-11	N.C.	TO THIS RELAY COIL, THRU NO. 4 TARGET SWITCH.
	20A	GRAY-G -Y-	B-7	N.O.	TO NO. 4 TARGET LITE.
NO. 5 RELAY	21C	-J- -J-	D-13	N.C.	IN SERIES WITH SWITCH 23C ON NO. 6 RELAY.
	21B	BR-G O-W	D-13	N.O.	PULSES 1,000 POINT RELAY, THRU SWITCH D ON EJECT RELAY.
	21A	-J- -J-	A-7	N.O.	IN SERIES WITH SWITCH 23A ON NO. 6 RELAY.
	22D	BR-Y -J- -J-	D-12	M&B	OPENS IN CIRCUIT TO 1,000 RELAY AND CLOSSES IN SERIES CIRCUIT TO 5,000 RELAY.
	22C	Y-O -J- -J-	D-12	M&B	OPENS IN CIRCUIT TO 5,000 RELAY, THRU HOOP ROLLOVER SWITCH, AND CLOSSES IN SERIES CIRCUIT TO "1 TO 6 RESET RELAY.
	22B	-J- BLU-B	E-12	N.C.	TO THIS RELAY COIL, THRU NO. 5 TARGET SWITCH.
	22A	GRAY-W -Y-	B-7	N.O.	TO NO. 5 TARGET LITE.

RELAY	SW.	WIRE COLORS	DIAGRAM LOCATION	TYPE	SWITCH OPERATION
NO. 6 RELAY	23C	W-R -J-	E-13	N.C.	CIRCUIT TO 100 POINT RELAY, THRU SWITCH E ON EJECT RELAY. (SEE SWITCH 13C ON NO. 1 RELAY.)
	23B	BR-O O-W	D-13	N.O.	PULSES 1,000 POINT RELAY, THRU SWITCH D ON EJECT RELAY.
	23A	-J- GRAY-O	A-7	N.O.	TO EXTRA BALL LITES AND LEFT AND RIGHT BOTTOM ROLLOVER LITES. (SEE SWITCH 13A ON NO. 1 RELAY.)
	24D	BR-Y -J- Y-O	E-12	M&B	OPENS IN CIRCUIT TO 1,000 RELAY AND CLOSES IN SERIES CIRCUIT TO 5,000 RELAY.
	24C	Y-O -J- Y-BR			OPENS IN CIRCUIT TO 5,000 RELAY, THRU HOOP ROLLOVER SWITCH, AND CLOSES IN SERIES CIRCUIT TO "1 TO 6 RESET RELAY).
	24B	-J- Y-BLU	E-12	N.C.	TO THIS RELAY COIL, THRU NO. 6 TARGET SWITCH.
	24A	GRAY-BR -Y-	B-7	N.O.	TO NO. 6 TARGET LITES.

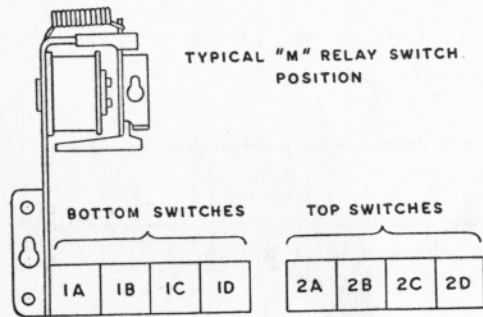

## RELAYS & SWITCHES LOCATED ON MECHANISM PANEL

### LOCK RELAY

IS ENERGIZED BY 5¢, 10¢, 25¢ OR COIN RELAYS---ALSO BY LEFT FLIPPER SWITCH.

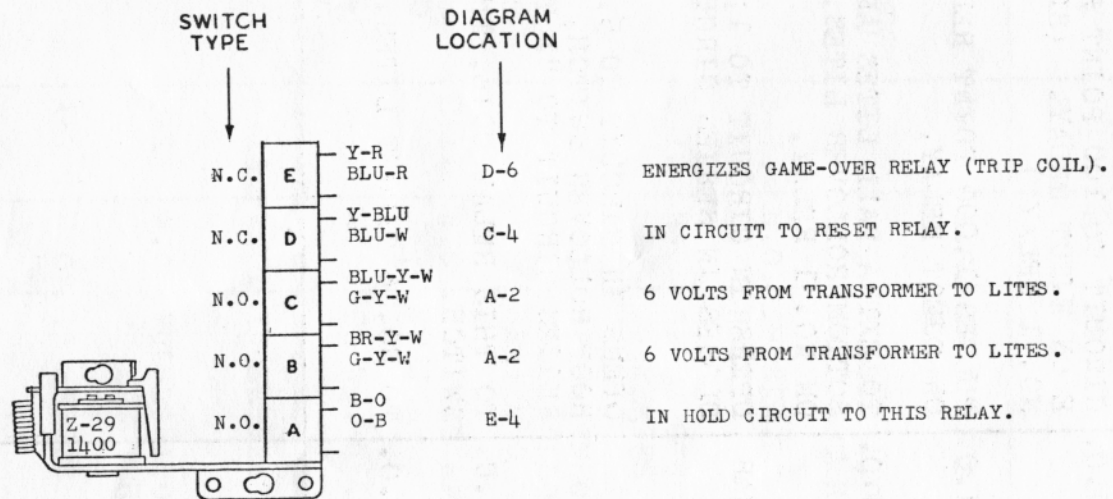

### BALL INDEX RELAY

IS ENERGIZED BY 100 POINT OR 1,000 POINT RELAY---ALSO BY OUTHOLE RELAY WHEN GAME IS TILTED.

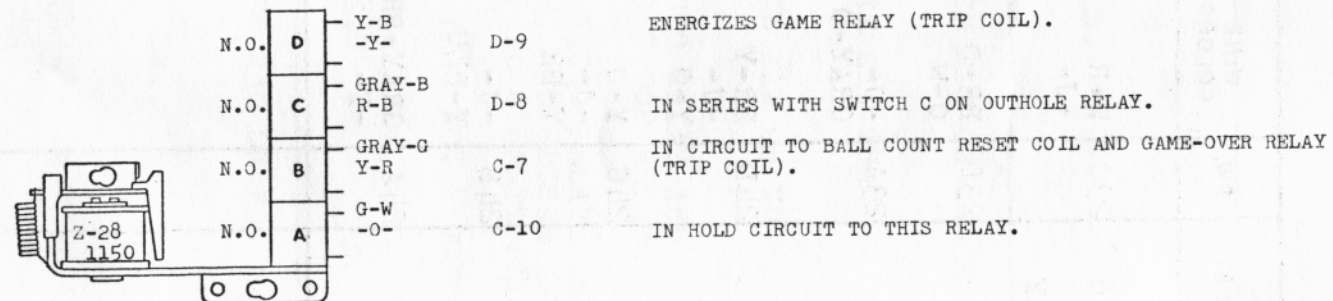

## EJECT RELAY

IS ENERGIZED BY EJECT POCKET SWITCH.

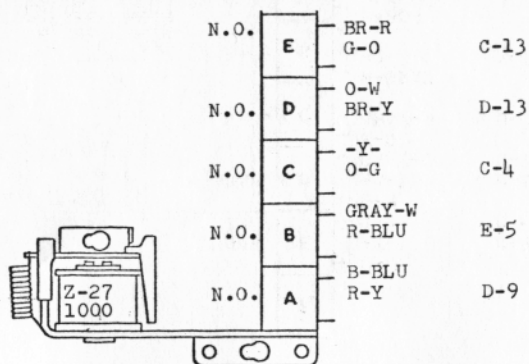

PULSES 100 POINT RELAY, THRU SWITCHES ON #1 THRU #6 RELAYS.

CIRCUIT TO 1000 POINT RELAY, THRU SWITCH ON #1, 2, 3, 4, 5 OR 6 RELAYS.

RUNS SCORE MOTOR.

ENERGIZES EJECT COIL AT SCORE MOTOR CAM SWITCH 4C.

HOLD CIRCUIT TO THIS RELAY, THRU SCORE MOTOR CAM SWITCH 6A.

## RESET RELAY

IS ENERGIZED BY SWITCH D ON COIN RELAY.

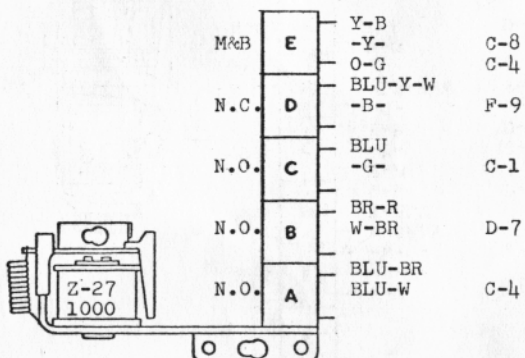

OPENS HI-SCORE CIRCUIT AND CLOSSES TO RUN SCORE MOTOR.

OPENS CIRCUITS TO PLAYFIELD SWITCHES.

TO BOTH RELAY BANK RESET COILS.

PULSES SCORE RESET RELAY, THRU IMPULSE CAM SWITCH B.

IN HOLD CIRCUIT TO THIS RELAY.

## COIN RELAY

IS ENERGIZED BY COIN SWITCH---ALSO BY REPLAY BUTTON, THRU ZERO SWITCH ON REPLAY UNIT.

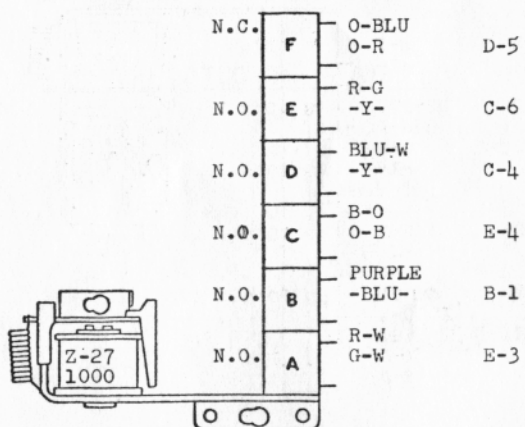

OPENS CIRCUIT TO KNOCKER COIL.

IN CIRCUIT TO GAME RELAY AND GAME-OVER RELAY (LATCH COILS); ALSO TO BALL COUNT UNIT RESET AND S.U. COILS.

ENERGIZES RESET RELAY.

ENERGIZES LOCK RELAY.

IN CIRCUIT TO BOTH RELAY BANK RESET COILS.

IN HOLD CIRCUIT TO THIS RELAY.

## GAME RELAY

LATCH COIL IS ENERGIZED BY COIN RELAY, WHEN BALL COUNT UNIT IS IN RESET POSITION. TRIP COIL IS ENERGIZED BY BALL INDEX RELAY OR GAME-OVER RELAY.

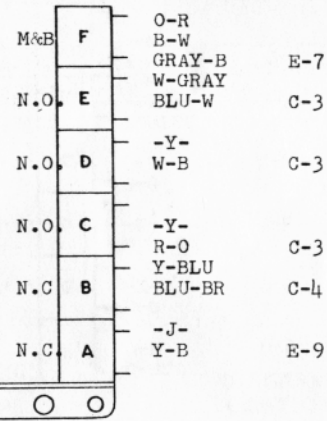
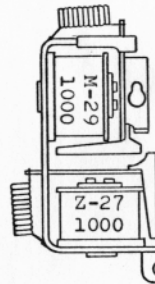

OPENS IN CIRCUIT TO BALL COUNT S.U. COIL AND CLOSSES TO BALL COUNT RESET COIL.

IN CIRCUIT TO COIN RELAY, THRY REPLAY BUTTON SWITCH.

IN HOLD CIRCUIT TO COIN RELAY, IN 5 BALL GAME.

IN HOLD CIRCUIT TO COIN RELAY, IN 3 BALL GAME.

IN SERIES WITH SWITCH D ON RESET RELAY.

TO GAME RELAY (TRIP COIL).

## GAME OVER RELAY

LATCH COIL IS ENERGIZED BY COIN RELAY. TRIP COIL IS ENERGIZED BY OUTHOLE RELAY AND BALL INDEX RELAY, THRU BALL COUNT UNIT DISC. TRIP COIL IS ALSO ENERGIZED BY LOCK RELAY OR TILT SWITCHES.

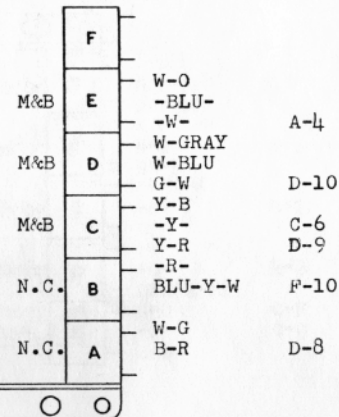
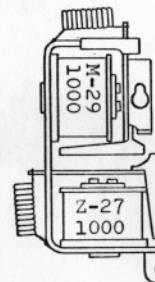

OPENS IN CIRCUIT TO PLAYFIELD LITES AND CLOSSES TO GAME-OVER, TILT AND NO. MATCH LITES.

OPENS IN CIRCUIT TO OUTHOLE RELAY AND CLOSSES TO BALL INDEX RELAY.

OPENS IN CIRCUIT TO TRIP COIL ON THIS RELAY AND CLOSSES TO TRIP COIL ON GAME RELAY.

IN SERIES WITH SWITCH D ON RESET RELAY.

IN HI-SCORE AND NO. MATCH CIRCUITS.

## OUTHOLE RELAY

IS ENERGIZED BY OUTHOLE SWITCH, THRU BALL COUNT UNIT ZERO SWITCH.

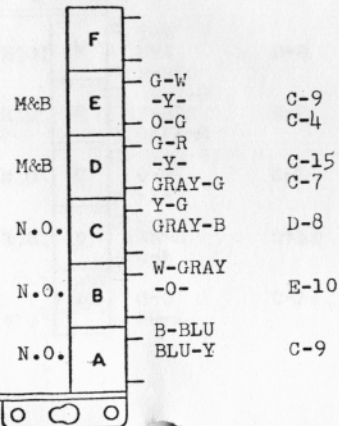
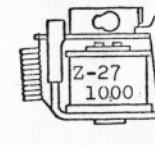

OPENS IN HOLD CIRCUIT TO BALL INDEX RELAY AND CLOSSES TO RUN SCORE MOTOR.

OPENS IN HOLD CIRCUIT TO "ON BUMPER" RELAY AND CLOSSES TO GAME-OVER RELAY COILS, BALL COUNT RESET AND BALL RELEASE SOLENOIDS.

IN NUMBER MATCH CIRCUIT TO REPLAY UNIT S.U. COIL.

IN CIRCUIT TO BALL INDEX RELAY.

IN HOLD CIRCUIT TO THIS RELAY.



## 5¢ RELAY

THIS RELAY IS USED IN CONJUNCTION WITH ALTERNATOR UNIT.  
IT IS ENERGIZED BY 5¢ COIN SWITCH.

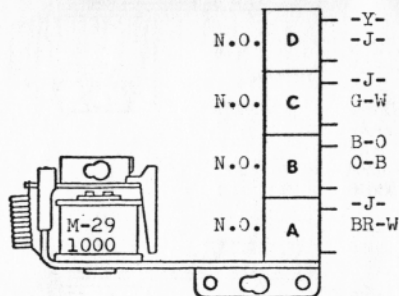

- C-2 ENERGIZES ALTERNATOR UNIT COIL.
- D-3 ENERGIZES COIN RELAY, THRU SWITCH ON ALTERNATOR UNIT.
- E-4 ENERGIZES LOCK RELAY.
- D-3 IN HOLD CIRCUIT TO THIS RELAY.

## 10¢ RELAY

IS ENERGIZED BY COIN SWITCH, IF 10¢ ADJUSTMENT JACK IS IN "2 PLAYS" OR "3 PLAYS" POSITION.

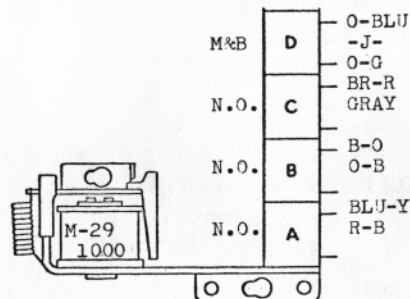

- C-5 OPENS IN CIRCUIT TO KNOCKER COIL AND CLOSSES TO RUN SCORE MOTOR.
- D-8 PULSES REPLAY S.U. COIL, THRU IMPULSE CAM SWITCH B.
- E-4 ENERGIZES LOCK RELAY.
- E-2 IN HOLD CIRCUIT TO THIS RELAY.

## 25¢ RELAY

IS ENERGIZED BY 25¢ COIN SWITCH.

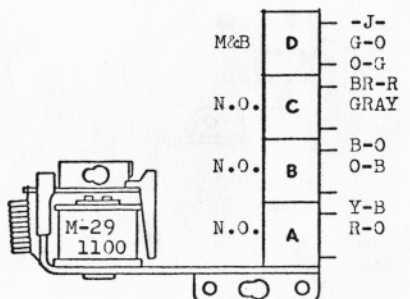

- C-5 OPENS IN CIRCUIT TO KNOCKER COIL AND CLOSSES TO RUN SCORE MOTOR.
- D-8 PULSES REPLAY S.U. COIL, THRU IMPULSE CAM SWITCH B.
- D-4 ENERGIZES LOCK RELAY.
- E-2 IN HOLD CIRCUIT TO THIS RELAY.

### LOCATED ON PLAYFIELD

## 1 TO 6 RESET RELAY

IS ENERGIZED BY HOOP ROLLOVER SWITCH (HORSESHOE), WHEN NO. 1 THRU NO. 6 RELAYS ARE TRIPPED.

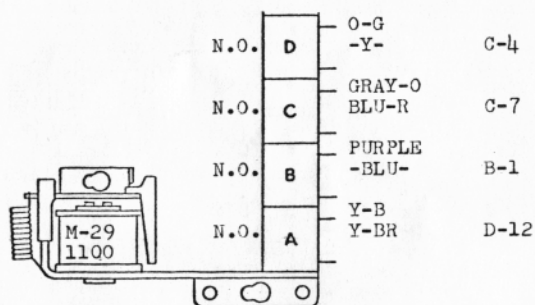

- C-4 RUNS SCORE MOTOR.
- C-7 PULSES BALL COUNT S.U. OR 10,000 POINT D.U. THRU SCORE MOTOR CAM SWITCH 2B.
- B-1 ENERGIZES 1-6 RELAY BANK RESET COIL---ALSO IN SERIES WITH SWITCH C ON RESET RELAY.
- D-12 HOLD CIRCUIT TO THIS RELAY, THRU SCORE MOTOR CAM SWITCH 5B.

## A TO E RESET RELAY

IS ENERGIZED WHEN ALL FIVE (5) A TO E RELAYS ARE TRIPPED.

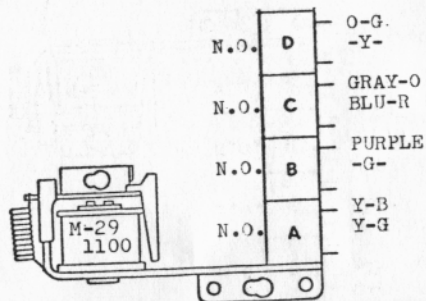

C-4

RUNS SCORE MOTOR.

C-7

PULSES BALL COUNT S.U. OR 10,000 POINT D.U. THRU SCORE MOTOR CAM SWITCH 2B.

B-1

ENERGIZES A TO E RELAY BANK RESET COIL---ALSO IN SERIES WITH SWITCH C ON RESET RELAY.

D-12

HOLD CIRCUIT TO THIS RELAY, THRU SCORE MOTOR CAM SWITCH 5B.

## 5000 RELAY

IS ENERGIZED BY HOOP ROLLOVER SWITCH (HORSESHOE)---ALSO BY LEFT OR RIGHT BOTTOM ROLLOVER SWITCH WHEN NO. 1 THRU NO. 6 RELAYS ARE TRIPPED.

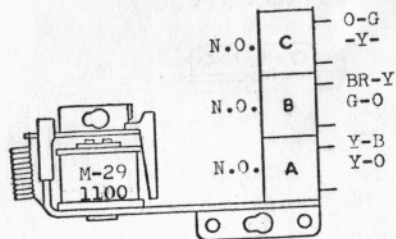

C-4

RUNS SCORE MOTOR.

D-13

PULSES 1,000 POINT RELAY, THRU IMPULSE CAM SWITCH C.

D-12

HOLD CIRCUIT TO THIS RELAY, THRU SCORE MOTOR CAM SWITCH 5B.

## ON BUMPER RELAY

IS ENERGIZED BY TOP ROLLOVER BUTTON SWITCH.

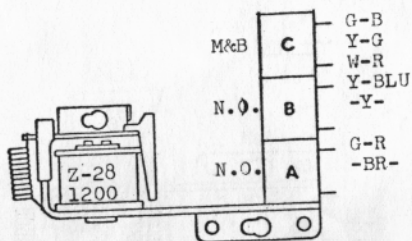

D-14

OPENS IN CIRCUIT TO 10 POINT RELAY AND CLOSES TO 100 POINT RELAY.

B-8

TO LEFT, RIGHT AND BOTTOM BUMPER LITES.

D-15

HOLD CIRCUIT TO THIS RELAY, THRU SWITCH ON OUTHOLE RELAY.

## SCORE RESET RELAY

IS PULSED BY IMPULSE CAM SWITCH B, THRU SWITCH ON RESET RELAY.

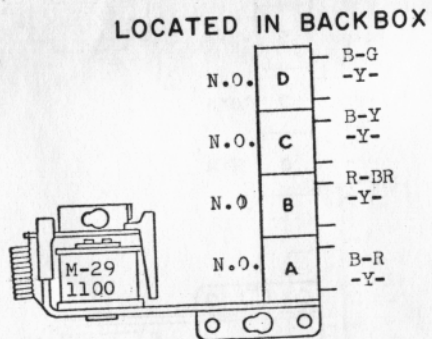

D-6

PULSES 10,000 POINT DRUM UNIT, THRU ZERO SWITCH ON THAT UNIT.

D-5

PULSES 1,000 POINT DRUM UNIT, THRU ZERO SWITCH ON THAT UNIT.

D-5

PULSES 100 POINT DRUM UNIT, THRU ZERO SWITCH ON THAT UNIT.

D-5

PULSES 10 POINT DRUM UNIT, THRU ZERO SWITCH ON THAT UNIT.

## 100,000 RELAY

IS ENERGIZED BY 10,000 POINT DRUM UNIT E.O.S. SWITCH, THRU 10,000 POINT DRUM UNIT 9TH POSITION SWITCH.

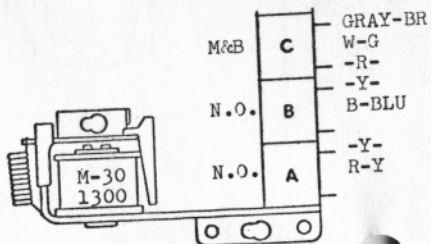

D-8

IN HI-SCORE CIRCUIT, THRU HI-SCORE ADJUSTMENT JACK.

B-2

TO 100,000 LITE.

D-10

HOLD CIRCUIT TO THIS RELAY.

## 1000 POINT RELAY

IS ENERGIZED BY:

1. (6) TARGET SWITCHES.
2. A TO E ROLLOVER SWITCHES.
3. LEFT & RIGHT BOTTOM ROLLOVER SWITCHES.
4. 5,000 RELAY.
5. EJECT RELAY.

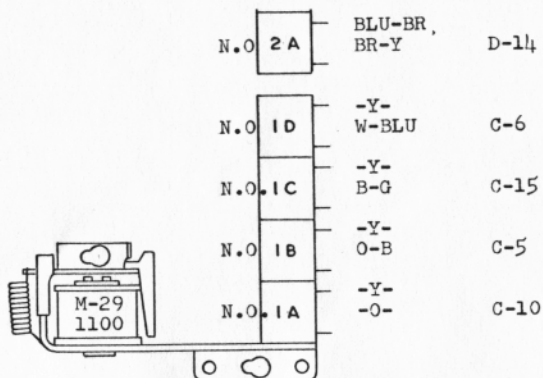

## 100 POINT RELAY

IS PULSED BY:

1. EJECT RELAY, WHEN NO. 1 THRU NO. 6 RELAYS ARE NOT TRIPPED.
2. CENTER JET BUMPER SWITCH.
3. LEFT, RIGHT AND BOTTOM JET BUMPER SWITCHES, THRU SWITCH C ON "ON BUMPER" RELAY.

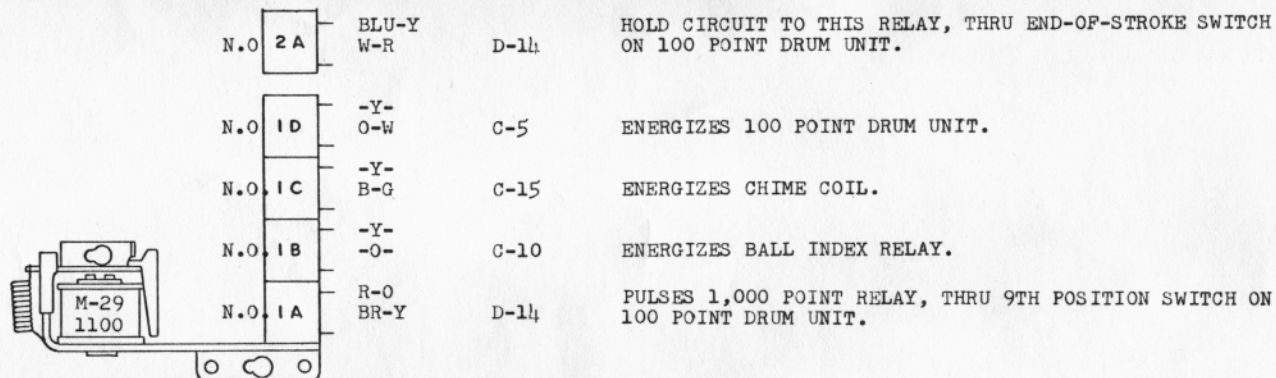

## 10 POINT RELAY

IS PULSED BY:

1. STANDUP SWITCHES.
2. ROLLOVER BUTTON SWITCHES, AS INDICATED ON PLAYFIELD.
3. LEFT, RIGHT AND BOTTOM JET BUMPER SWITCHES, THRU SWITCH C ON "ON BUMPER" RELAY.

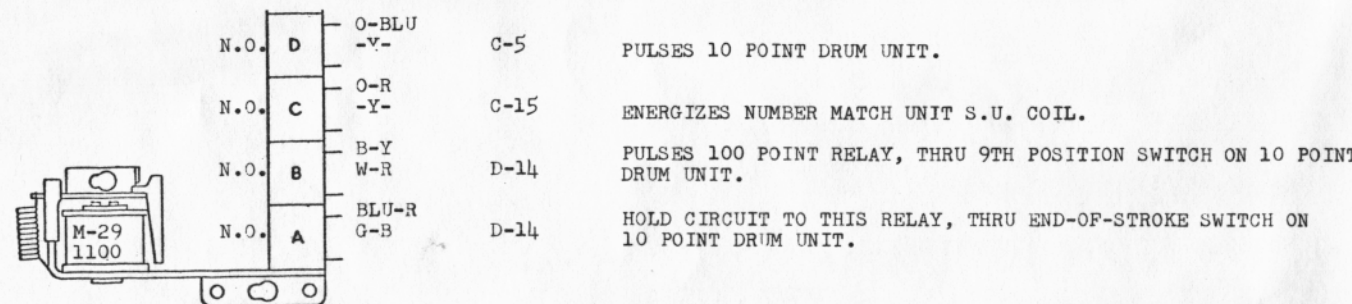

## SILICON BRIDGE RECTIFIER

PART NO. 5A-8741

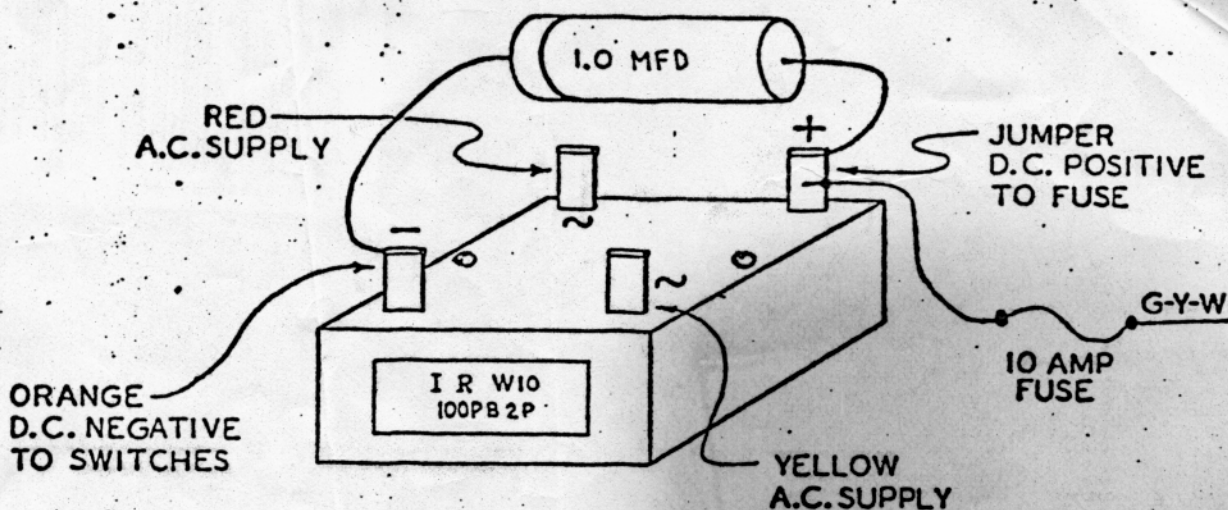

## SILICON BRIDGE RECTIFIER

5A-8749

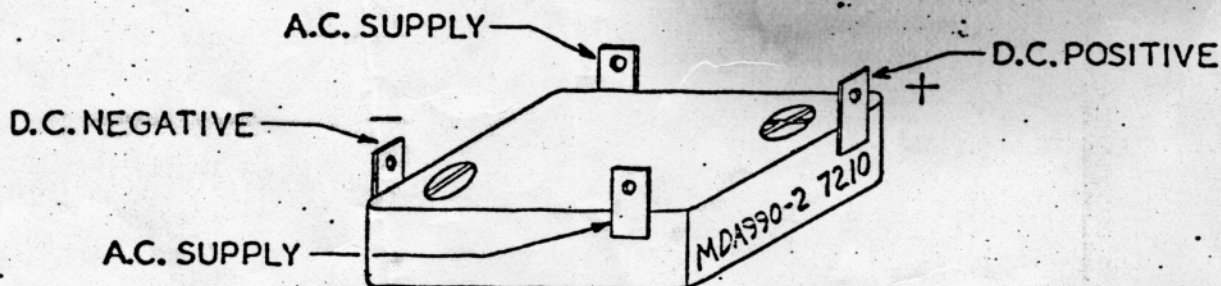

THE FUNCTION OF THE RECTIFIER AND CAPACITOR IS TO CONVERT THE ALTERNATING CURRENT (A.C.) TO DIRECT CURRENT (D.C.), SUPPLYING D.C. TO THE BUMPERS, KICKERS ETC.

THE BRIDGE RECTIFIER SHOULD PRACTICALLY NEVER NEED REPLACING, AS IT IS RATED WELL OVER THE VOLTAGE AND CURRENT REQUIREMENTS OF THE COMPONENTS IT SUPPLIES.

IF, HOWEVER, THE 15 AMP 24 VOLT FUSE ON THE MECHANISM PANEL OPENS, IT COULD BE DUE TO A FAULTY RECTIFIER. DISCONNECT THE A.C. INPUT TO RECTIFIER, REPLACE FUSE, AND RECHECK.

IF THE 10 AMP FUSE LOCATED NEXT TO THE RECTIFIER OPENS, CHECK ALL D.C. COMPONENTS I.E. BUMPERS, KICKERS ETC. FOR SHORTS.

EITHER ONE OF THE ABOVE RECTIFIERS MAY BE USED.

# CATALOG SUPPLEMENT "P-P"

WITH  
NEW PARTS & UNITS

FOR

# SPANISH EYES



*Williams*<sup>®</sup> ELECTRONICS, INC.

SUBSIDIARY OF THE SEEBURG CORPORATION

3401 N. California Ave.  
Phone 267-2240

Chicago, Ill. 60618, U.S.A.  
Cable Address: Wilcoin

# SPLIT BANK ASSEMBLY

## D-7429

5 & 6 POS.

Used on "Spanish Eyes"

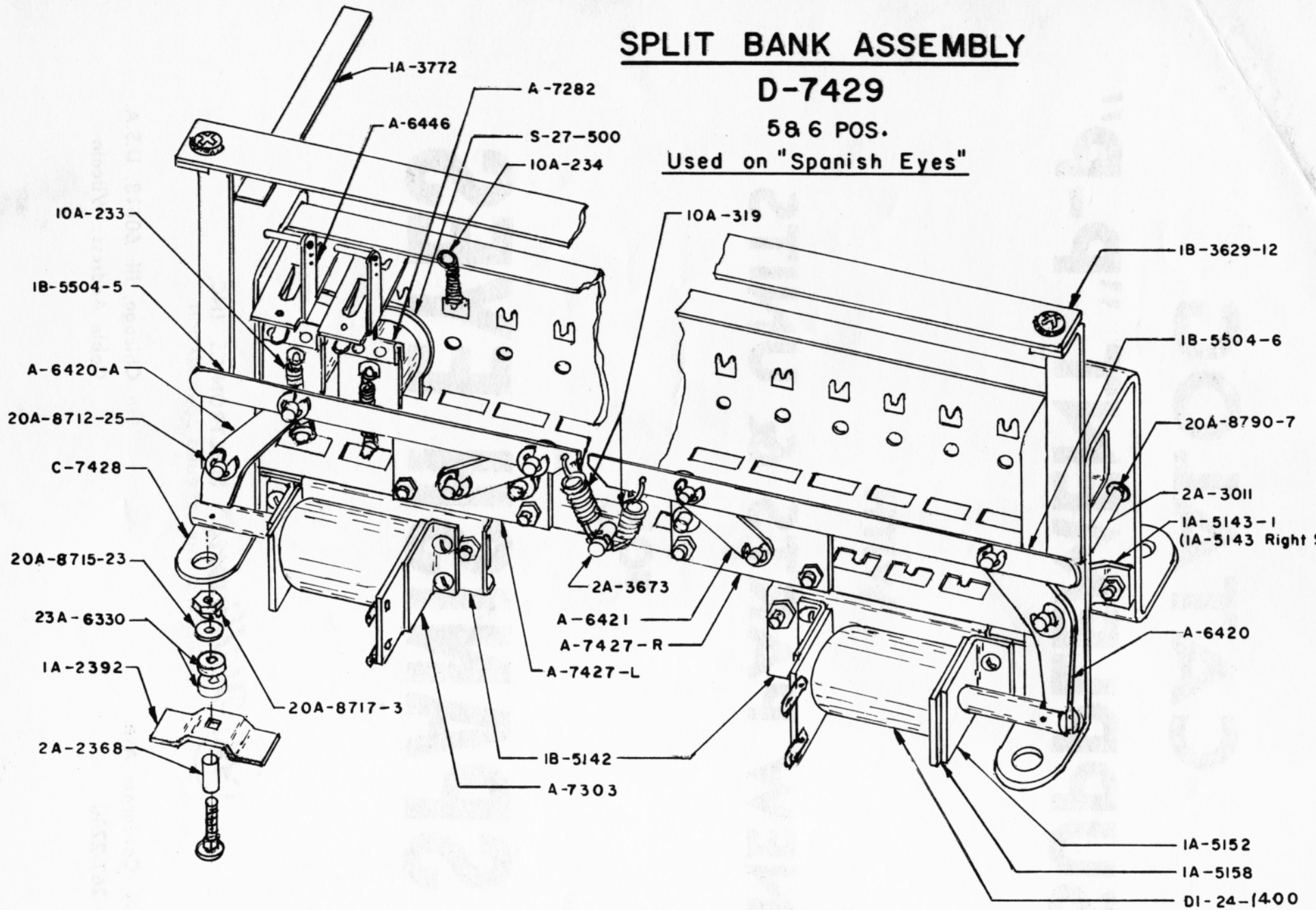

# B-7418-1 JET BUMPER ASSEMBLY

## D.C. TYPE

SPECIFY STAMPING AND COLOR ON ALL BUMPER CAPS  
1st USED ON "SPANISH EYES"

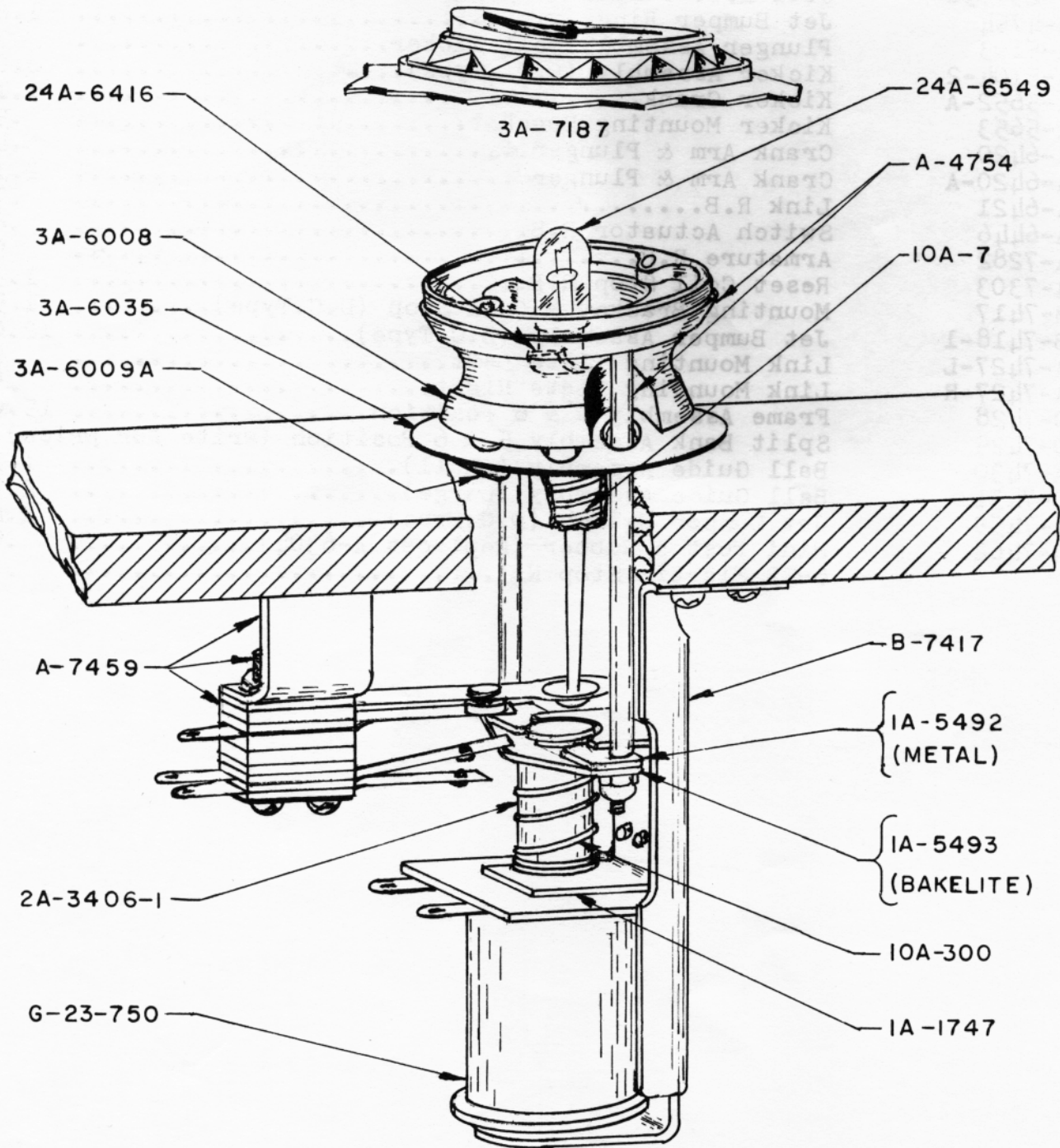

B-7431  
BALL GUIDE  
ASSEMBLY

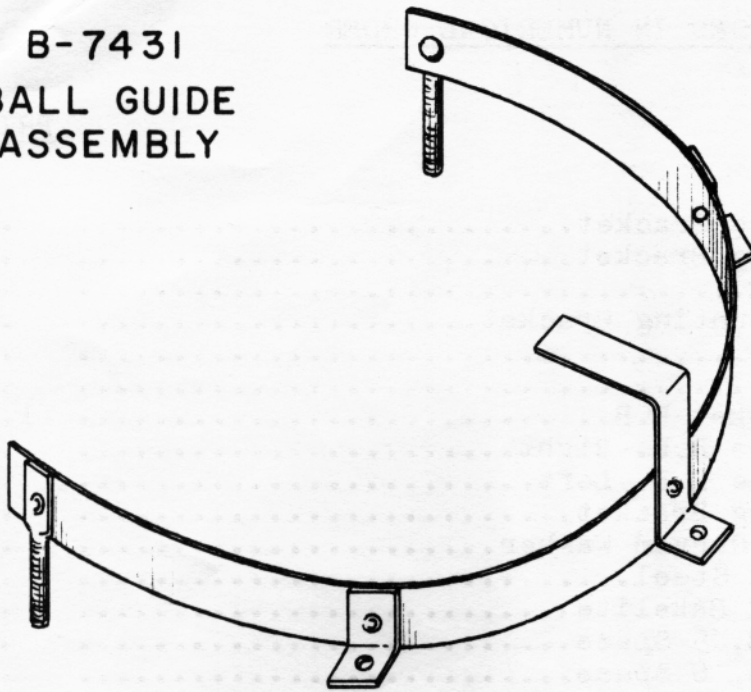

A-7430  
BALL GUIDE ASSEMBLY

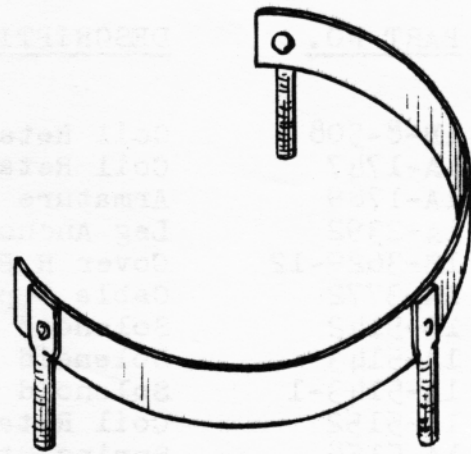

B-5104-2 BALL KICKER ASSEMBLY  
(D.C. KICKER)

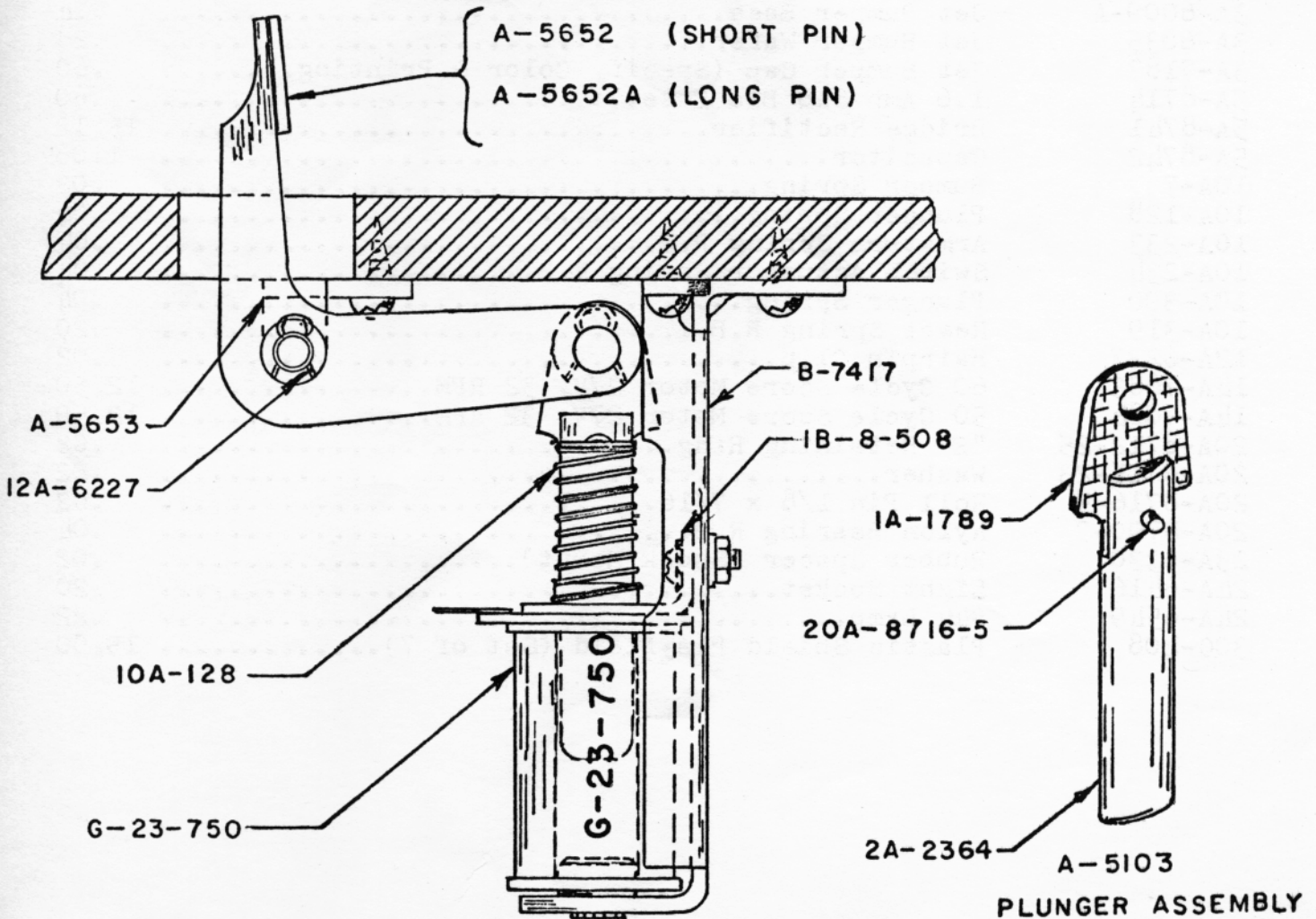



PRICE LIST

ARRANGED IN NUMERICAL ORDER

<u>PART NO.</u>	<u>DESCRIPTION</u>	<u>PRICE</u>
1B-8-508	Coil Retaining Bracket.....	.10
1A-1747	Coil Retaining Bracket.....	.34
1A-1789	Armature Link.....	.14
1A-2392	Leg Anchor-Mounting Bracket.....	.10
1B-3629-12	Cover R.B.....	.82
1A-3772	Cable Support.....	.26
1B-5142	Solenoid Bracket R.B.....	1.46
1A-5143	Solenoid Brace R.B. Right.....	.34
1A-5143-1	Solenoid Brace R.B. Left.....	.34
1A-5152	Coil Retaining Bracket.....	.64
1A-5158	Spring Steel Curved Washer.....	.38
1A-5492	Armature Link Steel.....	.14
1A-5493	Armature Link Bakelite.....	.32
1B-5504-5	Reset Bar R.B. 5 Space.....	.70
1B-5504-6	Reset Bar R.B. 6 Space.....	.74
2A-2364	Solenoid Plunger.....	.38
2A-2368	Shock Mount Bushing.....	.06
2A-3011	Pivot Pin.....	.14
2A-3406-1	Solenoid Plunger.....	.22
2A-3673	Spring Post.....	.36
3A-6008	Jet Bumper Body.....	.28
3A-6009-A	Jet Bumper Base.....	.14
3A-6035	Jet Bumper Wafer.....	.28
3A-7187	Jet Bumper Cap (Specify Color & Printing.....	.60
5A-8714	1.6 Amp Slo Blo Fuse.....	.60
5A-8741	Bridge Rectifier.....	15.12
5A-8742	Capacitor.....	1.06
10A-7	Bumper Spring.....	.02
10A-128	Plunger Spring.....	.04
10A-233	Armature Spring R.B.....	.04
10A-234	Switch Actuator Spring R.B.....	.04
10A-300	Plunger Spring.....	.04
10A-319	Reset Spring R.B.....	.20
12A-6227	Hairpin Clip.....	.02
14A-7883	60 Cycle Score Motor 27V. 32 RPM.....	12.50
14A-7884	50 Cycle Score Motor 27V. 32 RPM.....	12.50
20A-8712-25	"E" Retaining Ring.....	.02
20A-8715-23	Washer.....	.02
20A-8716-5	Roll Pin 1/8 x 7/16.....	.02
20A-8790-7	Nylon Bearing R.B.....	.04
23A-6330	Rubber Spacer (Shock Mount).....	.02
24A-6416	Light Socket.....;	.20
24A-6549	#44 Lamp.....	.22
30C-408	Plastic Shield Playfield (Set of 7).....	19.00

PRICE LIST

ARRANGED IN NUMERICAL ORDER

<u>PART NO.</u>	<u>DESCRIPTION</u>	<u>PRICE</u>
S-27-500	Coil Relay Bank.....	1.24
D1-24-1400	Coil Reset Relay Bank.....	3.80
G-23-750	Coil D.C. Bumper & Kicker.....	2.00
A-4754	Jet Bumper Ring.....	1.68
A-5103	Plunger Assembly Ball Kicker.....	.78
A-5104-2	Kicker Assembly (D.C. Type).....	8.00
A-5652-A	Kicker Crank.....	1.14
A-5653	Kicker Mounting Bracket.....	.54
A-6420	Crank Arm & Plunger.....	3.46
A-6420-A	Crank Arm & Plunger.....	2.10
A-6421	Link R.B.....	.72
A-6446	Switch Actuator R.B.....	.60
A-7282	Armature R.B.....	.90
A-7303	Reset Coil Stop R.B.....	1.36
B-7417	Mounting Bracket & Coil Stop (D.C.Type).....	1.56
B-7418-1	Jet Bumper Assembly (D.C.Type).....	12.00
A-7427-L	Link Mounting Plate Left.....	.92
A-7427-R	Link Mounting Plate Right.....	.92
C-7428	Frame Assembly 5 & 6 Position.....	15.00
D-7429	Split Bank Assembly 5 & 6 Position (write for price)	
A-7430	Ball Guide Assembly (Small).....	1.22
B-7431	Ball Guide Assembly (Large).....	2.18
A-7459	Jet Bumper Switch (D.C.Type).....	2.40
A-7462	Mini Post & Rubber (Replaces A-6304).....	.82
	6-32 Elastic Stop Nut.....	.08



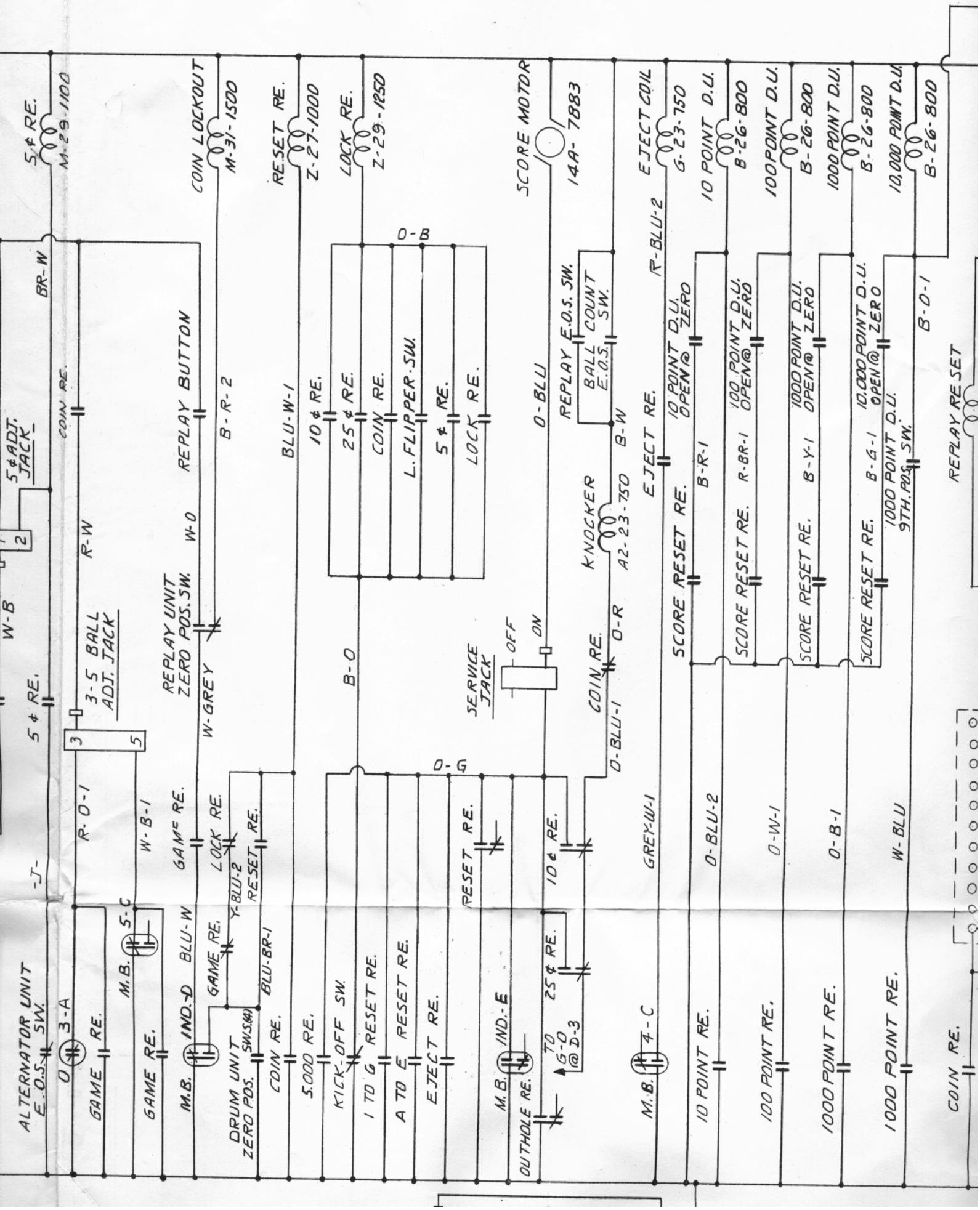

TO RED FEED

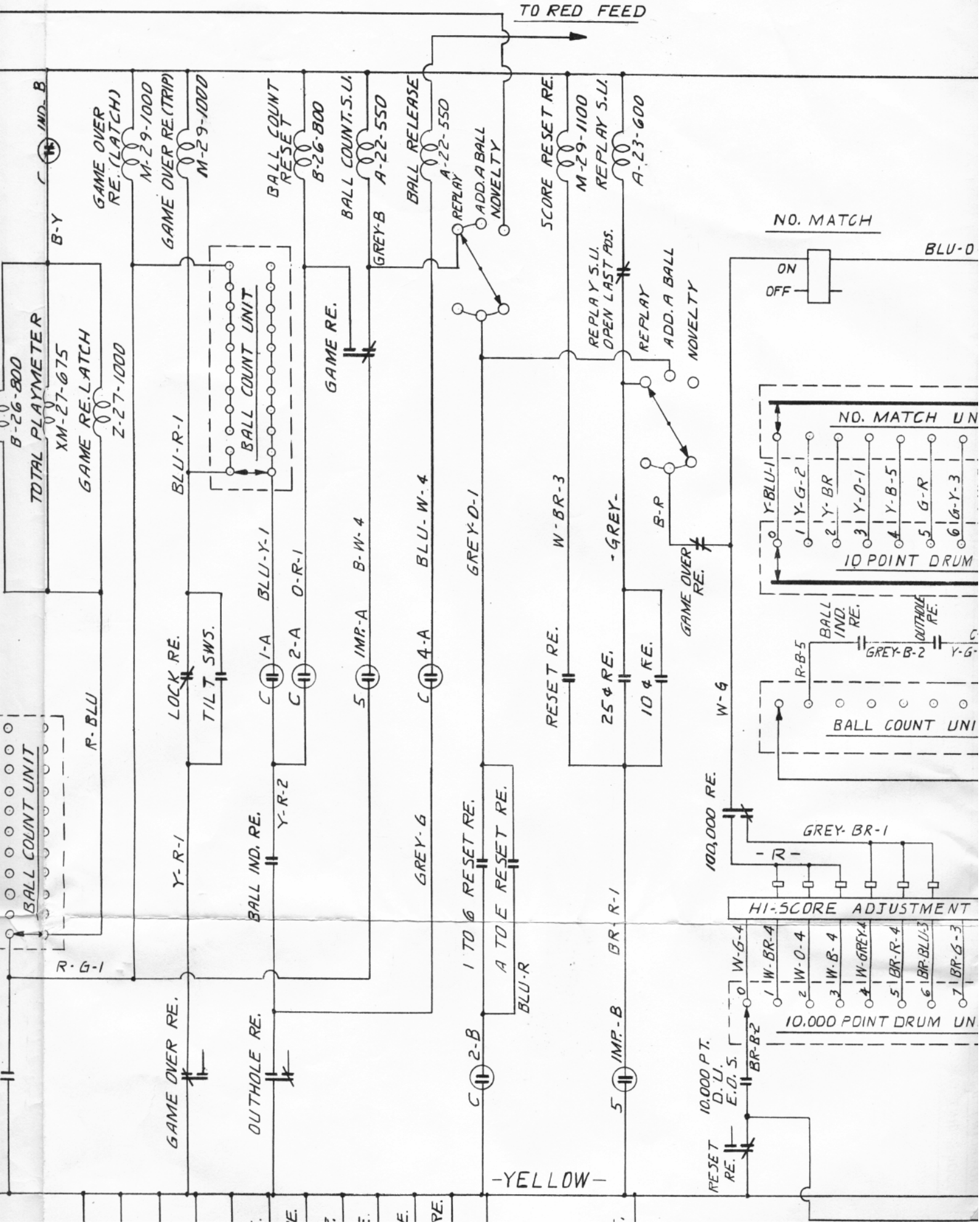

-BLACK-

-RED-

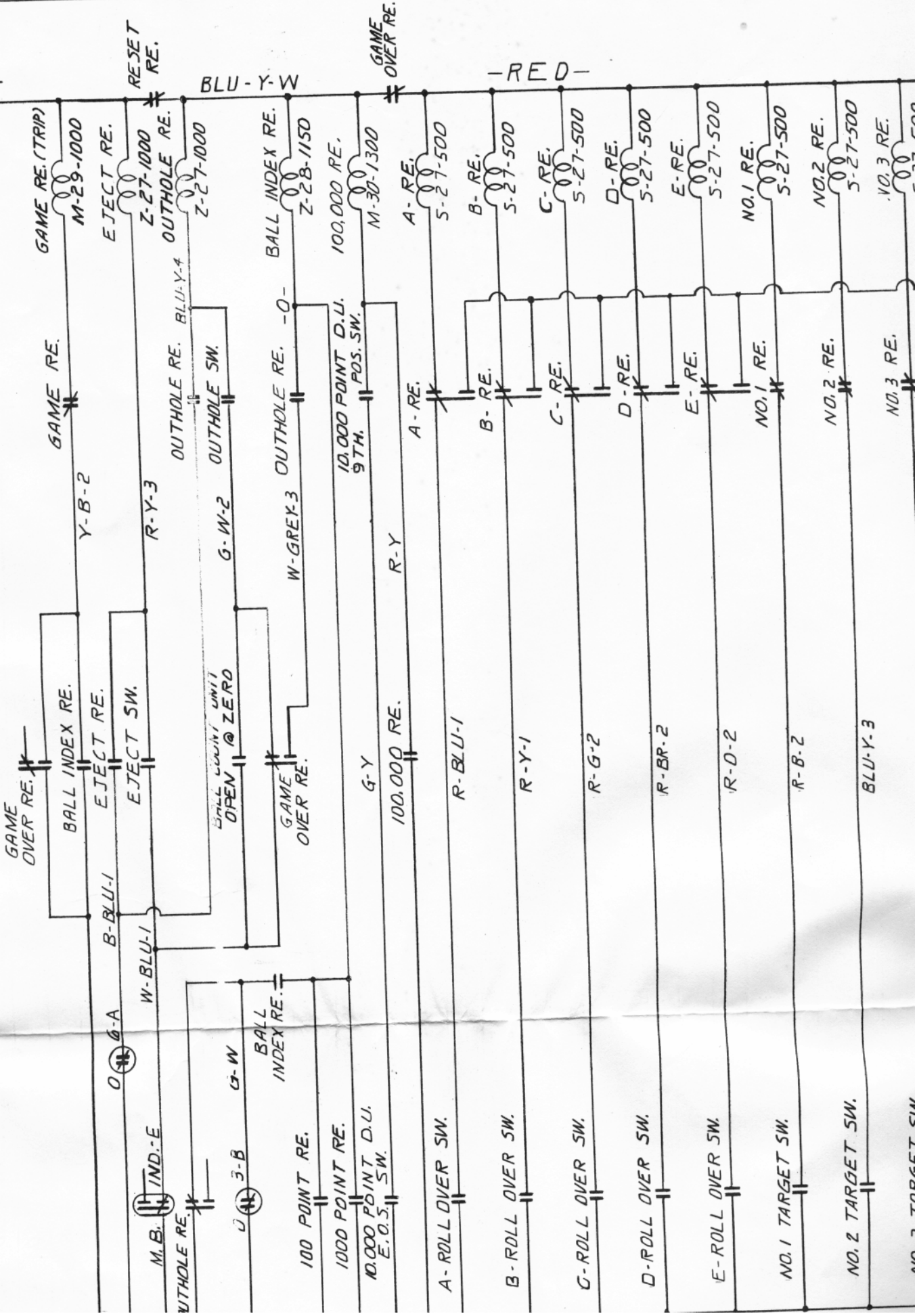
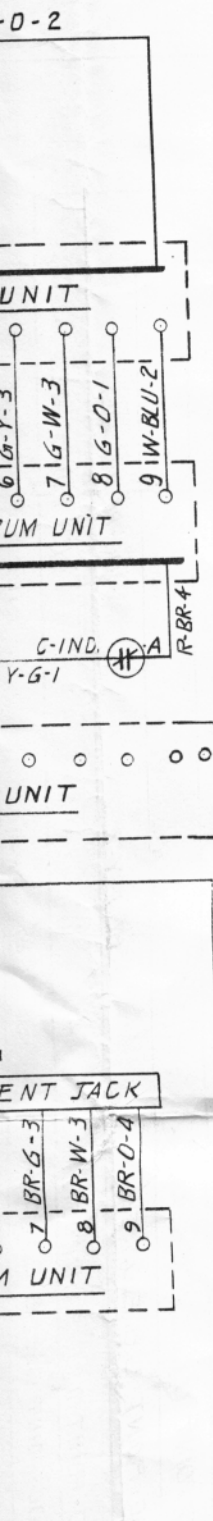

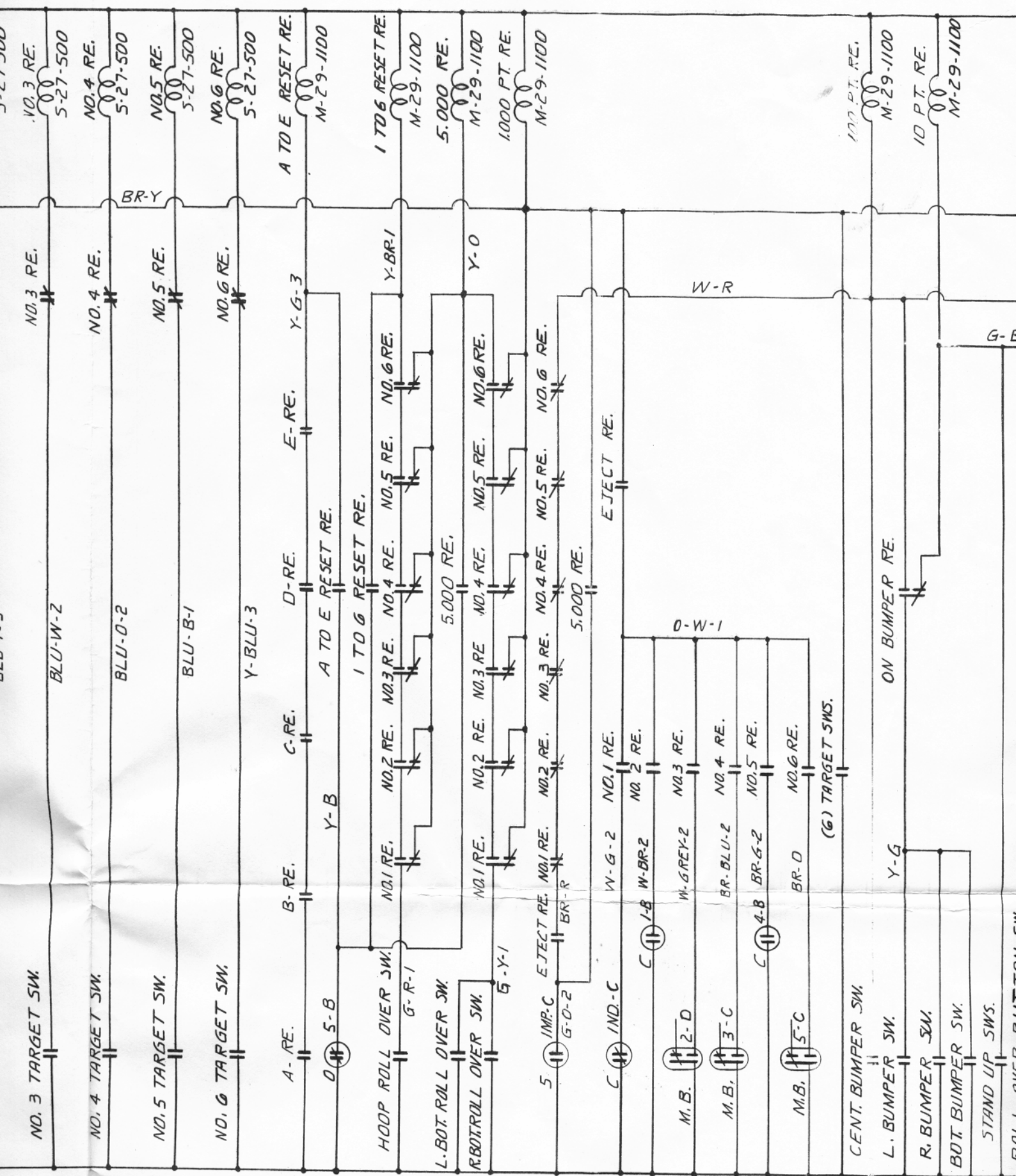

- YELLOW -

RELAY COIL LOCATION

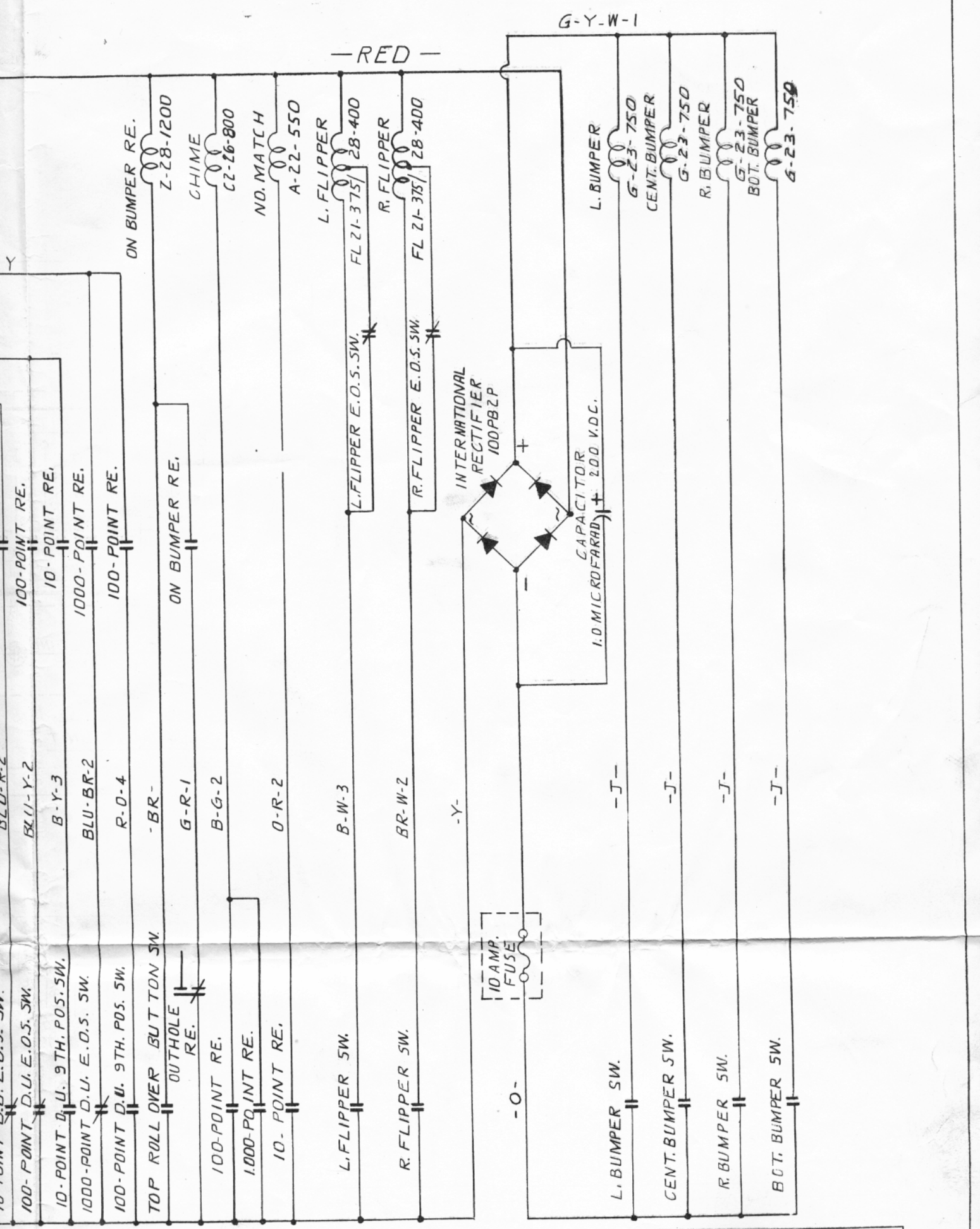

G-Y-W-1

— RED —

100-POINT D.U. E.O.S. SW.  
10-POINT D.U. 9TH. POS. SW.  
1000-POINT D.U. E.O.S. SW.  
100-POINT D.U. 9TH. POS. SW.  
TOP ROLL OVER BUTTON SW.  
100-POINT RE.  
1000-POINT RE.  
10-POINT RE.  
L. FLIPPER SW.  
R. FLIPPER SW.

ON BUMPER RE.  
Z-28-1200  
CHIME  
C2-26-800  
NO. MATCH  
A-22-550  
L. FLIPPER  
FL 21-375/28-400  
R. FLIPPER  
FL 21-375/28-400

BLU-R-2  
BLU-Y-2  
B-Y-3  
BLU-BR-2  
R-O-4  
-BR-  
G-R-1  
B-G-2  
O-R-2  
B-W-3  
BR-W-2

10 AMP. FUSE

INTERNATIONAL RECTIFIER 100PB2P  
CAPACITOR 1.0 MICRORFARAD 200 V.D.C.

L. BUMPER SW.  
CENT. BUMPER SW.  
R. BUMPER SW.  
BOT. BUMPER SW.

L. BUMPER  
G-23-750  
CENT. BUMPER  
G-23-750  
R. BUMPER  
G-23-750  
BOT. BUMPER  
G-23-750

-O-

-Y-

-J-

-J-

-J-

-J-



**WILLIAMS**  
 ELECTRONICS INC.  
 3401 N. CALIFORNIA AVENUE  
 CHICAGO, ILLINOIS, 60618  
 BY: D.C./A.V.

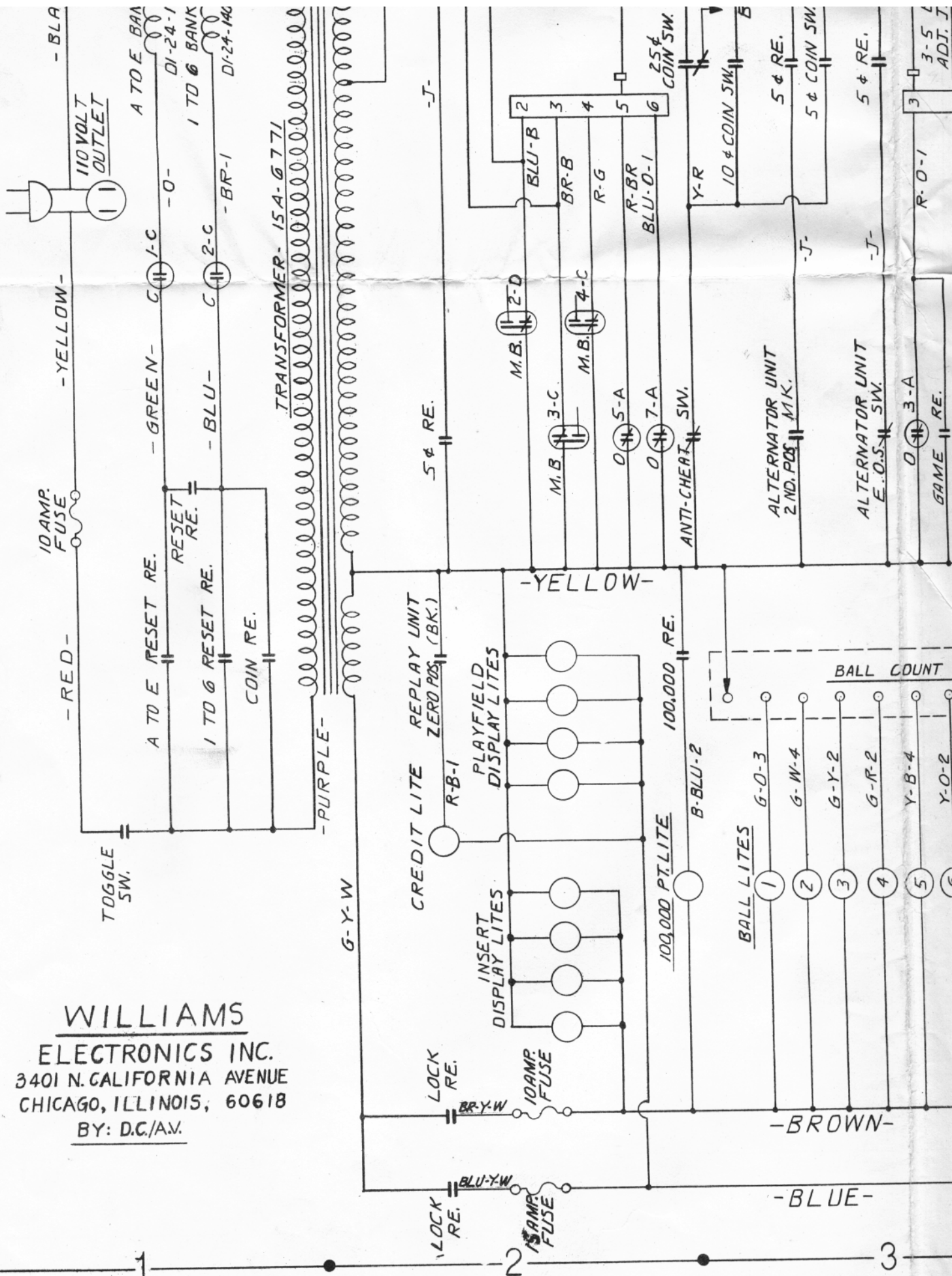

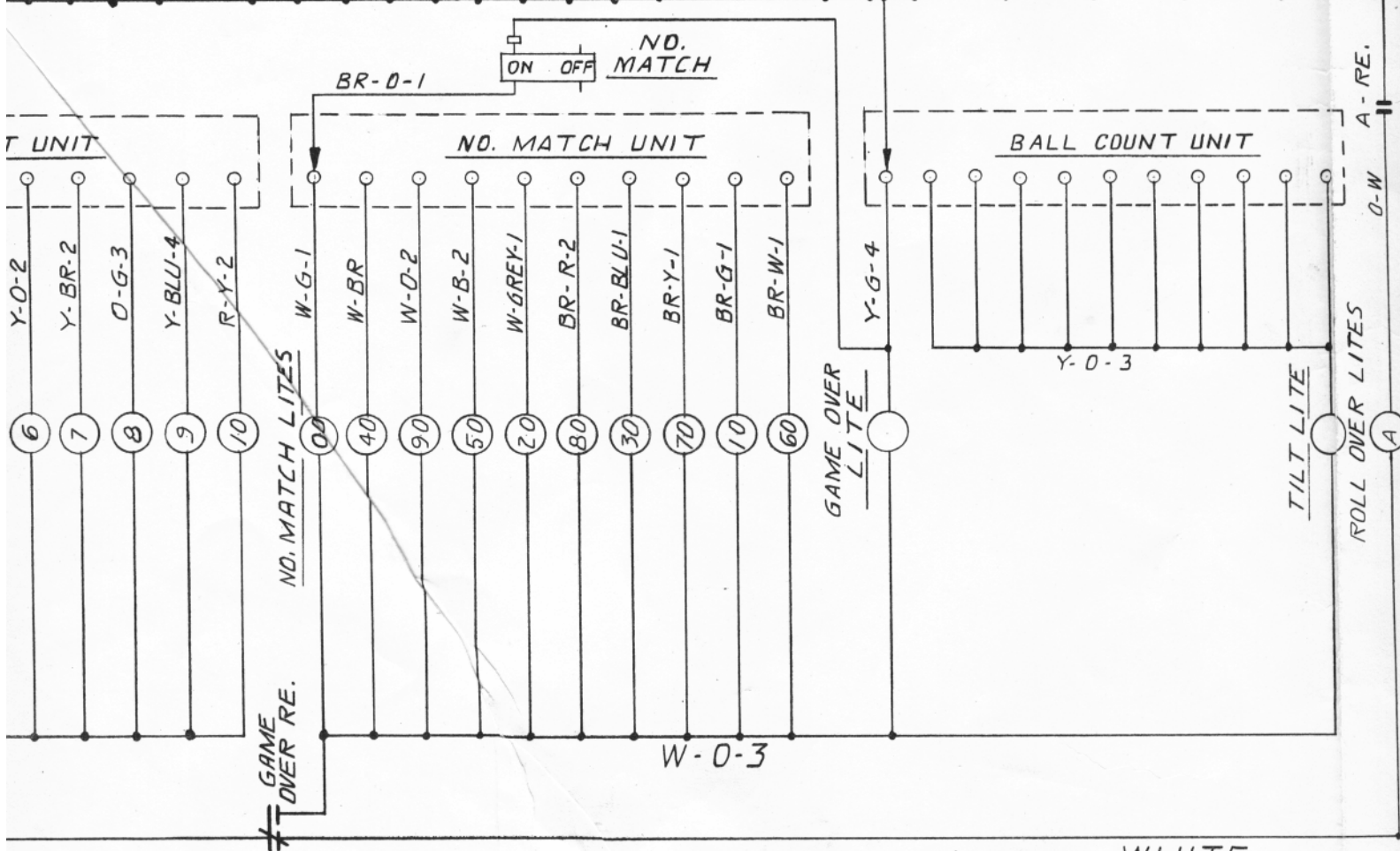
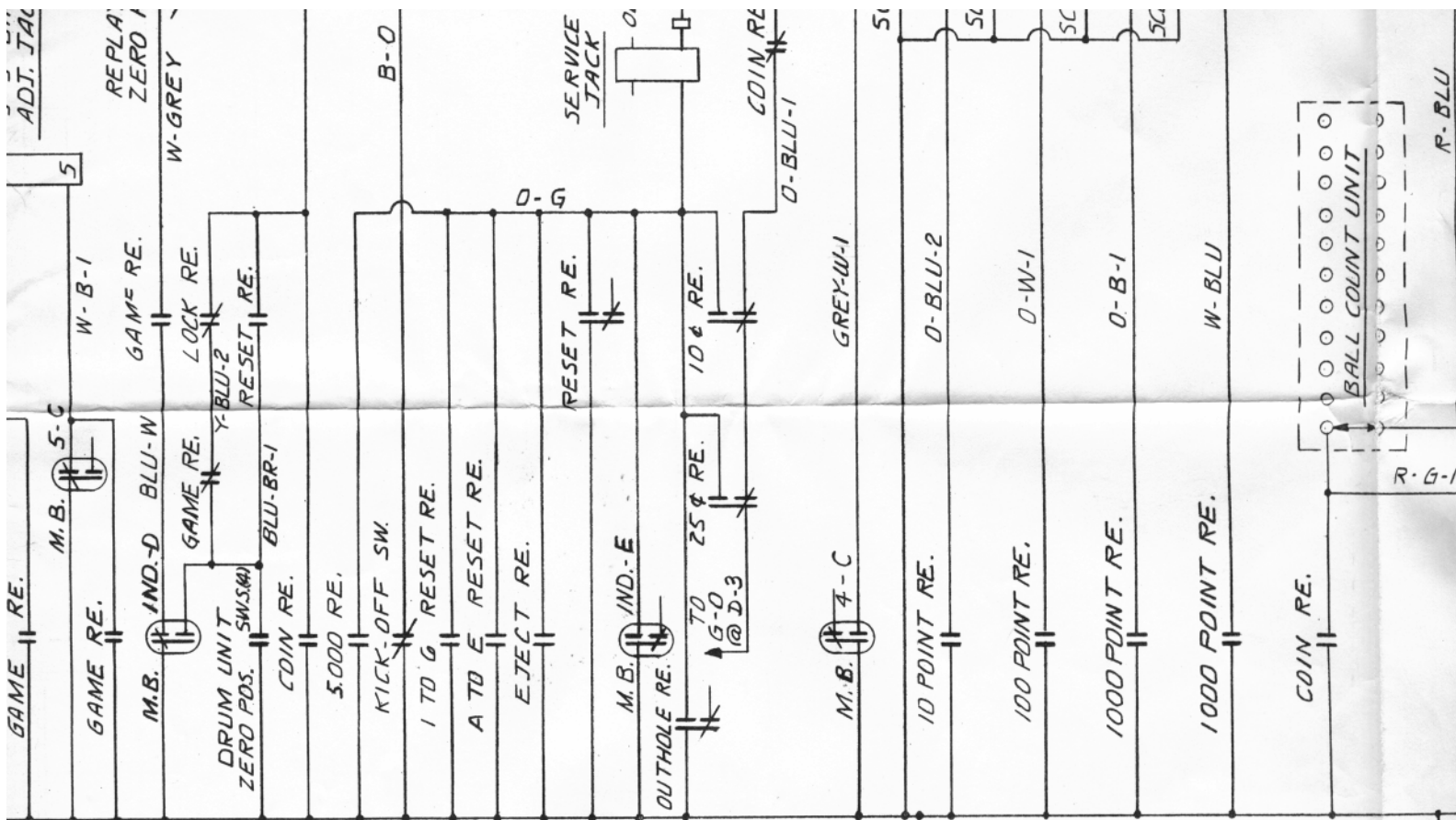

- WHITE -

4

5

6

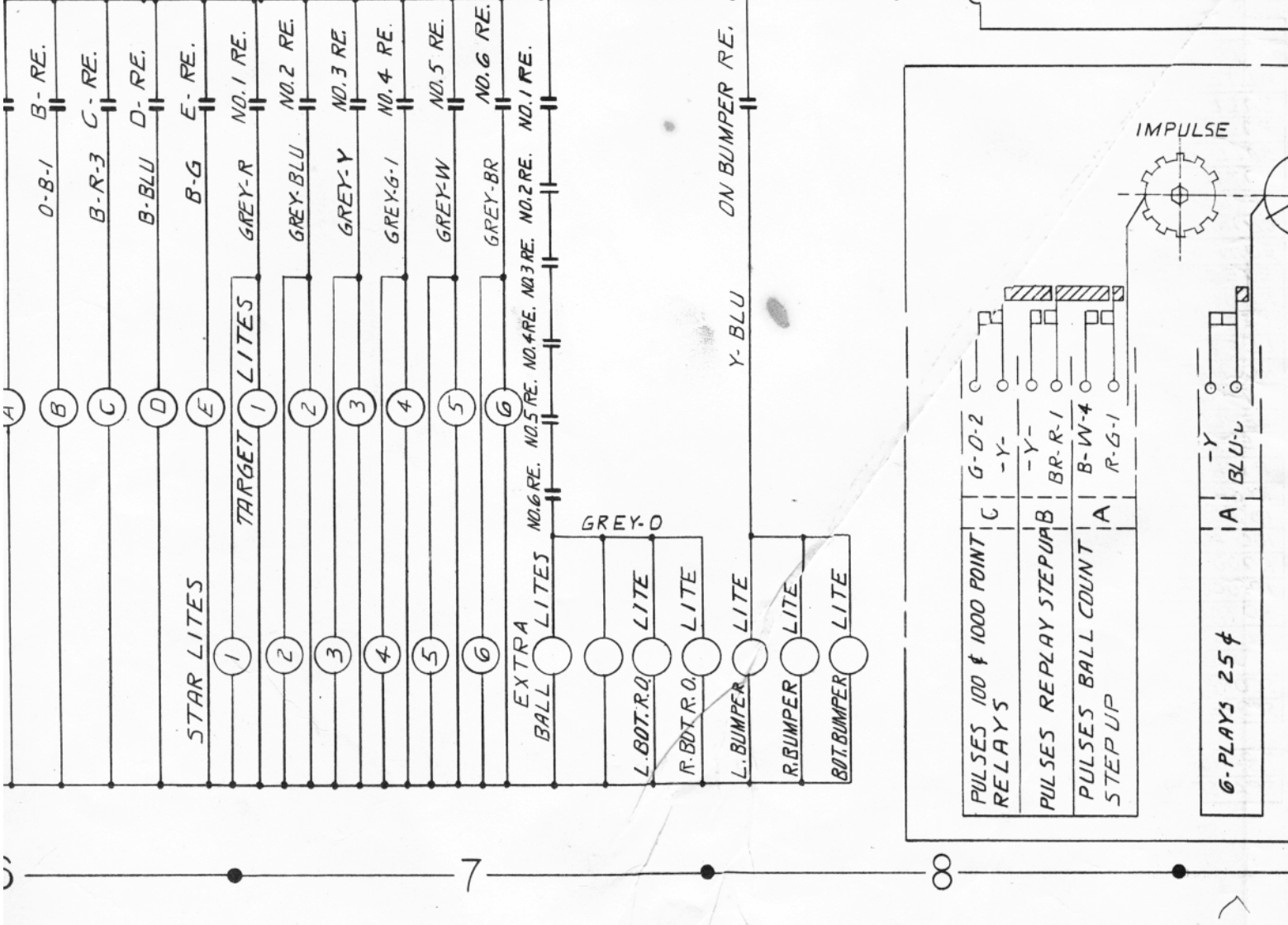
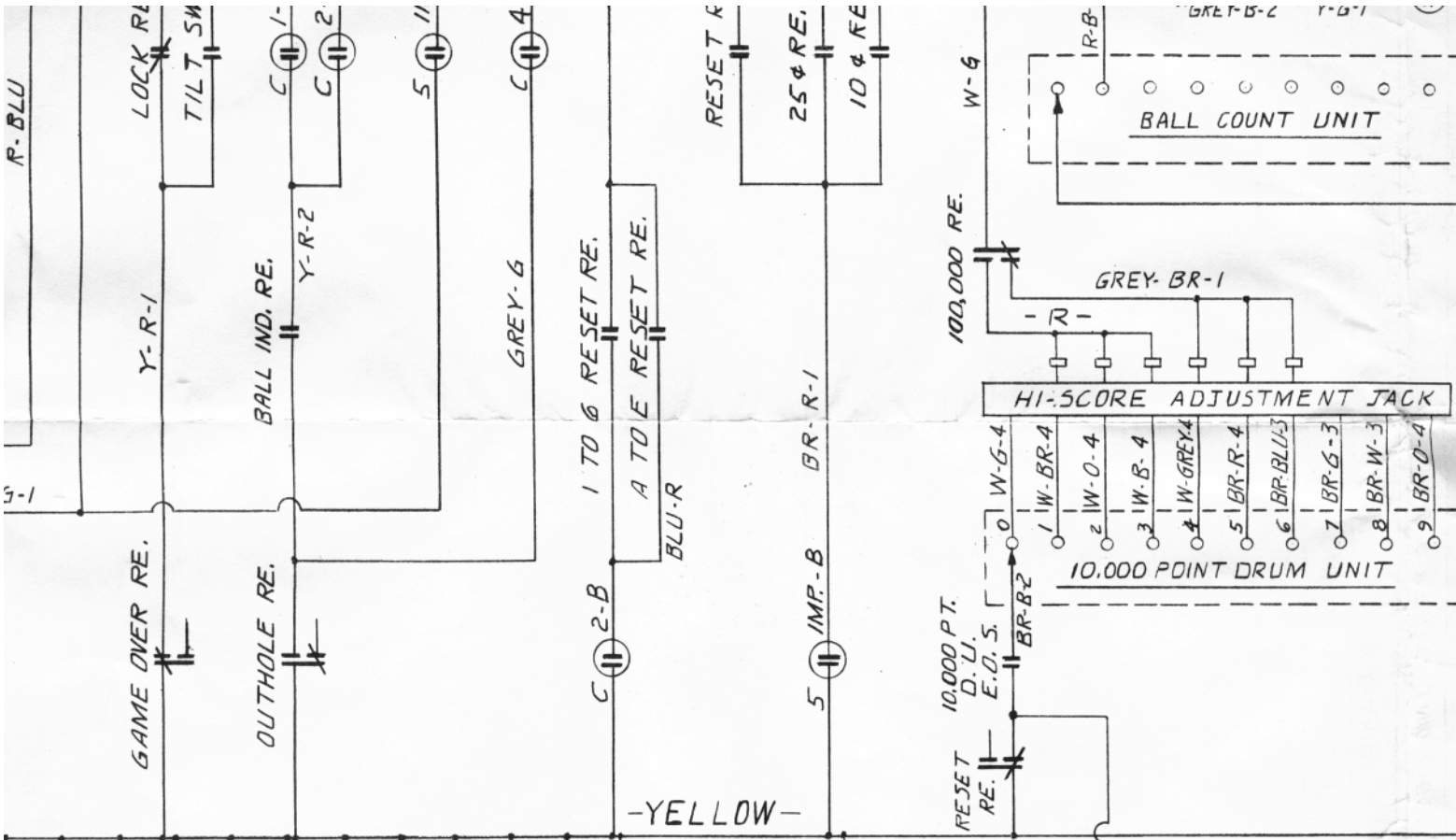

-YELLOW-

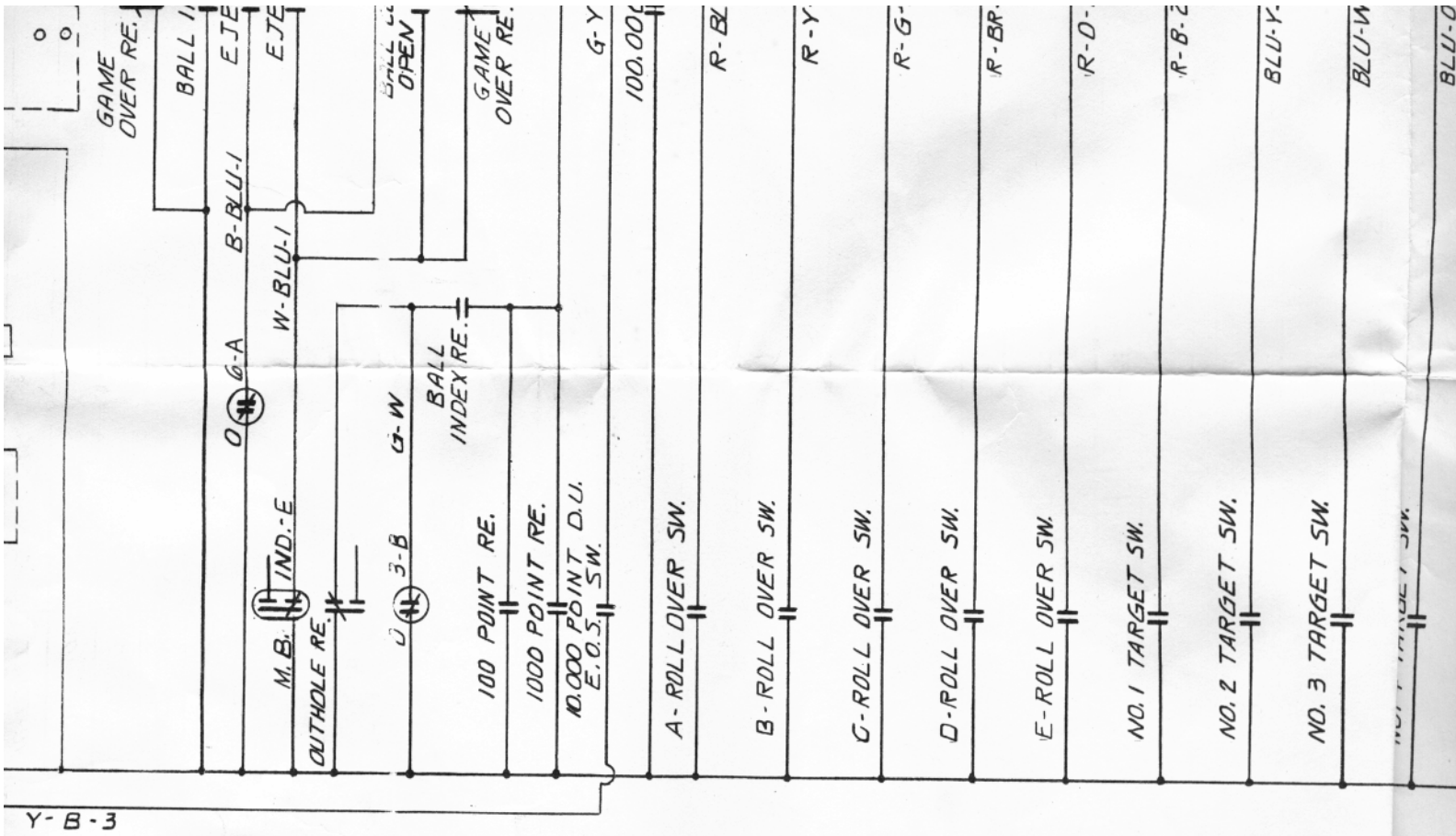

Y-B-3

### SCORE MOTOR

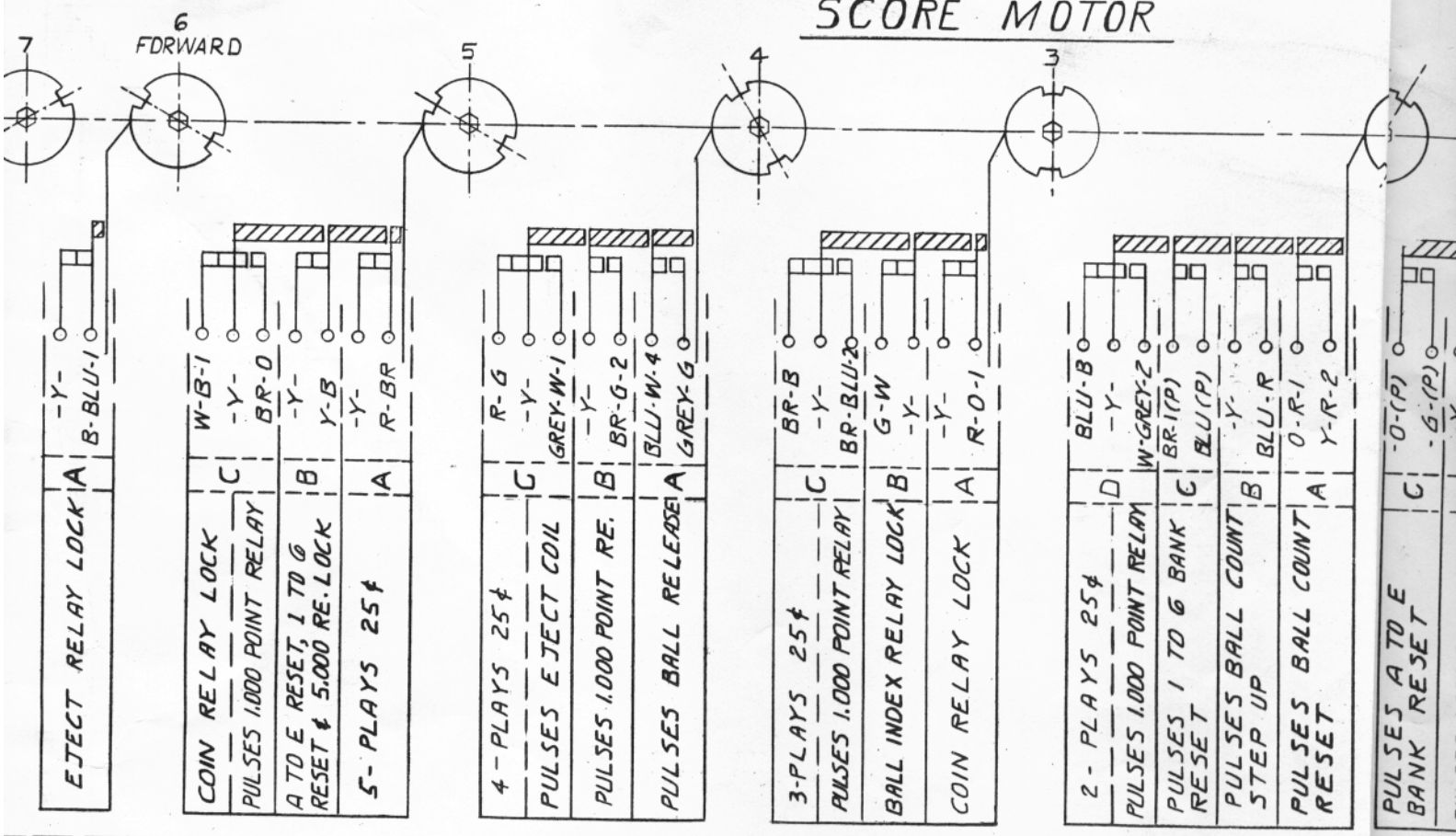

9

10

11

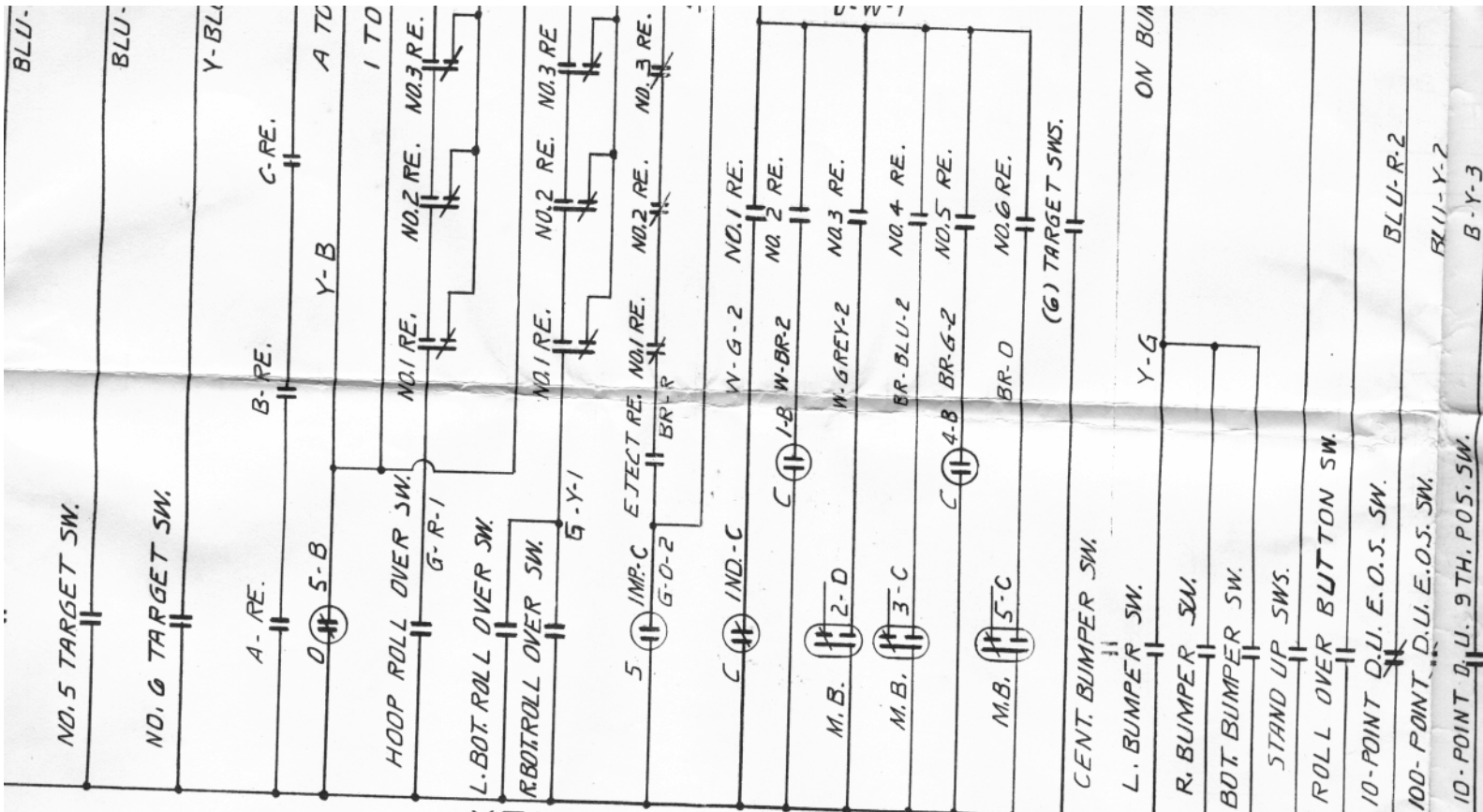

-YELLOW-

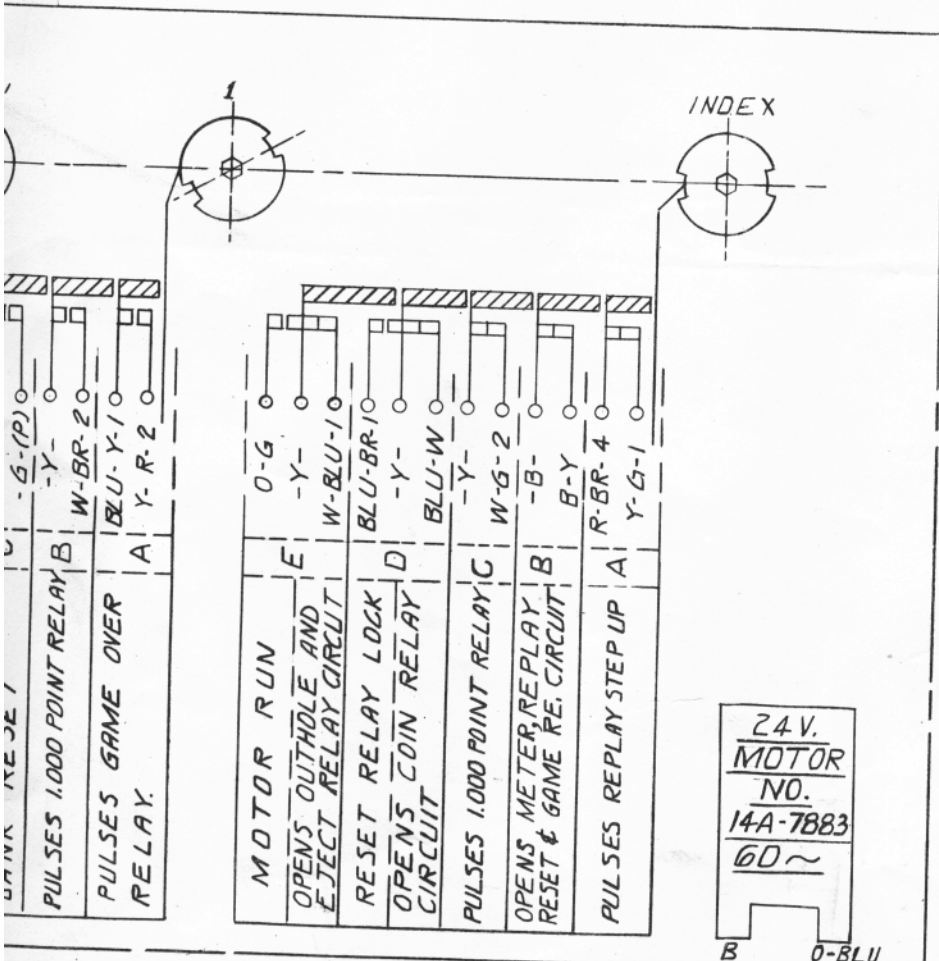

RELAY COIL LOCATION	
A-RE.	E-10
A TO E RESET RE.	E-12
B-RE.	E-10
BALL INDEX RE.	E-10
C-RE.	E-10
COIN RE.	E-3
D-RE.	E-11
E-RE.	E-11
EJECT RE.	E-9
5¢ RE.	E-3
5.000 RE.	E-12
GAME OVER RE. (LATCH)	E-6
GAME OVER RE. (TRIP)	E-6
GAME RE. (LATCH)	E-6
GAME RE. (TRIP)	E-9
100.000 RE.	E-10
LOCK RE.	E-4
NO. 1 RE.	E-11
NO. 2 RE.	E-11
NO. 3 RE.	E-11
NO. 4 RE.	E-11
NO. 5 RE.	E-12
NO. 6 RE.	E-12
ON BUMPER RE.	E-14
I TO G RESET RE.	E-12
OUTHOLE RE.	E-9
RESET RE.	E-4
SCORE RESET RE.	E-7
10¢ RE.	E-3
25¢ RE.	E-2
10 POINT RE.	E-14
100 POINT RE.	E-14
1,000 POINT RE.	E-13

COIL	
A TO E	
ALTERN	
BALL CO	
BALL C	
BAL. R	
BOTTOM	
CENTER	
CHIME	
CON LO	
EJECT	
KNOCKE	
LEFT B	
LEFT F	
NO. MATC	
I TO G L	
REPLAY	
REPLAY	
RIGHT	
RIGHT I	
10 POINT	
100 POINT	
1,000 PO	
10,000 PO	
TOTAL P	

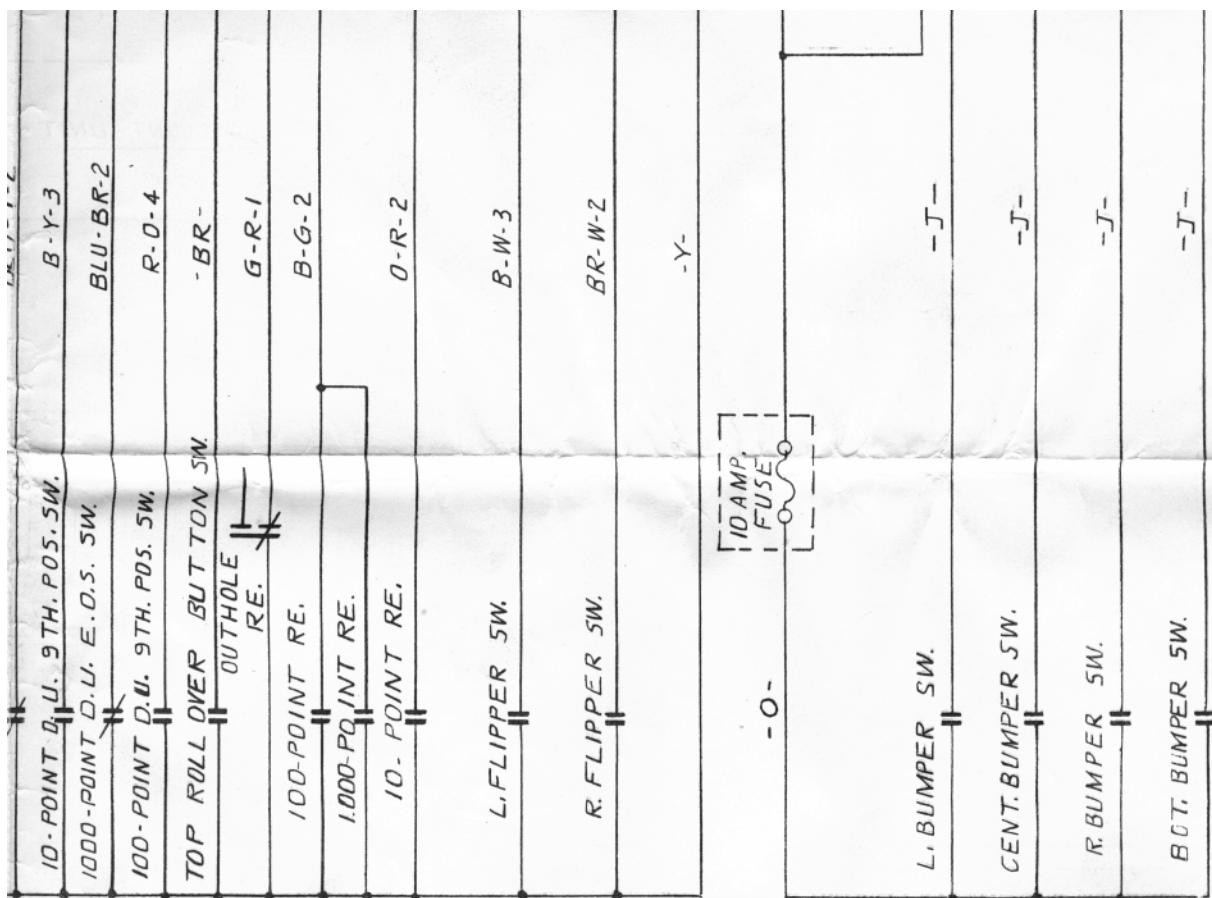

COIL LOCATION	
TO E BANK RESET	D-1
TERNATOR UNIT	E-2
ALL COUNT RESET	E-7
ALL COUNT STEP UP	E-7
ALL RELEASE	E-7
ATOM BUMPER	E-16
ENTER BUMPER	E-16
TIME	E-15
IN LOCKOUT	E-4
TECT COIL	E-5
LOCKER	D-5
FT BUMPER	E-16
FT FLIPPER	E-15
MATCH	E-15
TO G BANK RESET	D-1
PLAY RESET	E-6
PLAY STEP UP	E-8
SHFT BUMPER	E-16
SHFT FLIPPER	E-15
POINT DRUM UNIT	E-5
POINT DRUM UNIT	E-5
00 POINT DRUM UNIT	E-5
000 POINT DRUM UNIT	E-6
TAL PLAYMETER	E-6

ABBREVIATIONS	
ADJ.	ADJUSTMENT
AMP.	AMPERE
BOT.	BOTTOM
BK.	BREAK
BUT.	BUTTON
C.	CLOSE
CENT.	CENTER
D.U.	DRUM UNIT
E.O.S.	END OF STROKE
EX.	EXTRA
HI	HIGH
IMP.	IMPULSE
IND.	INDEX
J	JUMPER
L.	LEFT
MK.	MAKE
MB.	MAKE BREAK
NO.	NUMBER
O	OPEN
PT.	POINT
POS.	POSITION
RE.	RELAY
R.	RIGHT
R.O.	ROLL OVER
S.U.	STEP UP
SW.	SWITCH
SWS.	SWITCHES
V.	VOLT

SWITCH SYMBOLS	
	NORMALLY OPEN SWITCH MAKES WHEN ACTUATED.
	NORMALLY CLOSED SWITCH OPENS WHEN ACTUATED.
	MAKE BREAK SWITCH.
	CIRCLE INDICATES SWITCH ACTUATED BY A MOTOR CAM.

WIRE COLOR CODE			
RED	R	BROWN	BR
BLUE	BLU	ORANGE	O
YELLOW	Y	BLACK	B
GREEN	G	GREY	GREY
WHITE	W		

EXAMPLE: W-R INDICATES WHITE WIRE WITH A RED TRACER.  
W-R-1 INDICATES WHITE WIRE WITH A RED TRACER AND USED A SECOND TIME.

RE MOTOR	14A-7883	60~
RE MOTOR	14A-7884	50~
NSFORMER	15A-6771	60~
NSFORMER	15A-6782-1	50~

ALL INTERLOCK RELAYS ARE SHOWN IN LATCHED POSITION.