

# Instruction Manual for **SPACE MISSION**



**Williams**<sup>®</sup> ELECTRONICS

A SUBSIDIARY OF  
THE SEEBURG CORPORATION OF DELAWARE

3401 N. California Ave.  
(312) 267-2240

JAN.  
1976

Chicago, Ill. 60618, U.S.A.  
Cable Address: Wilcoin



**B-7894**  
**JET BUMPER ASSEMBLY**  
**(D.C. TYPE)**

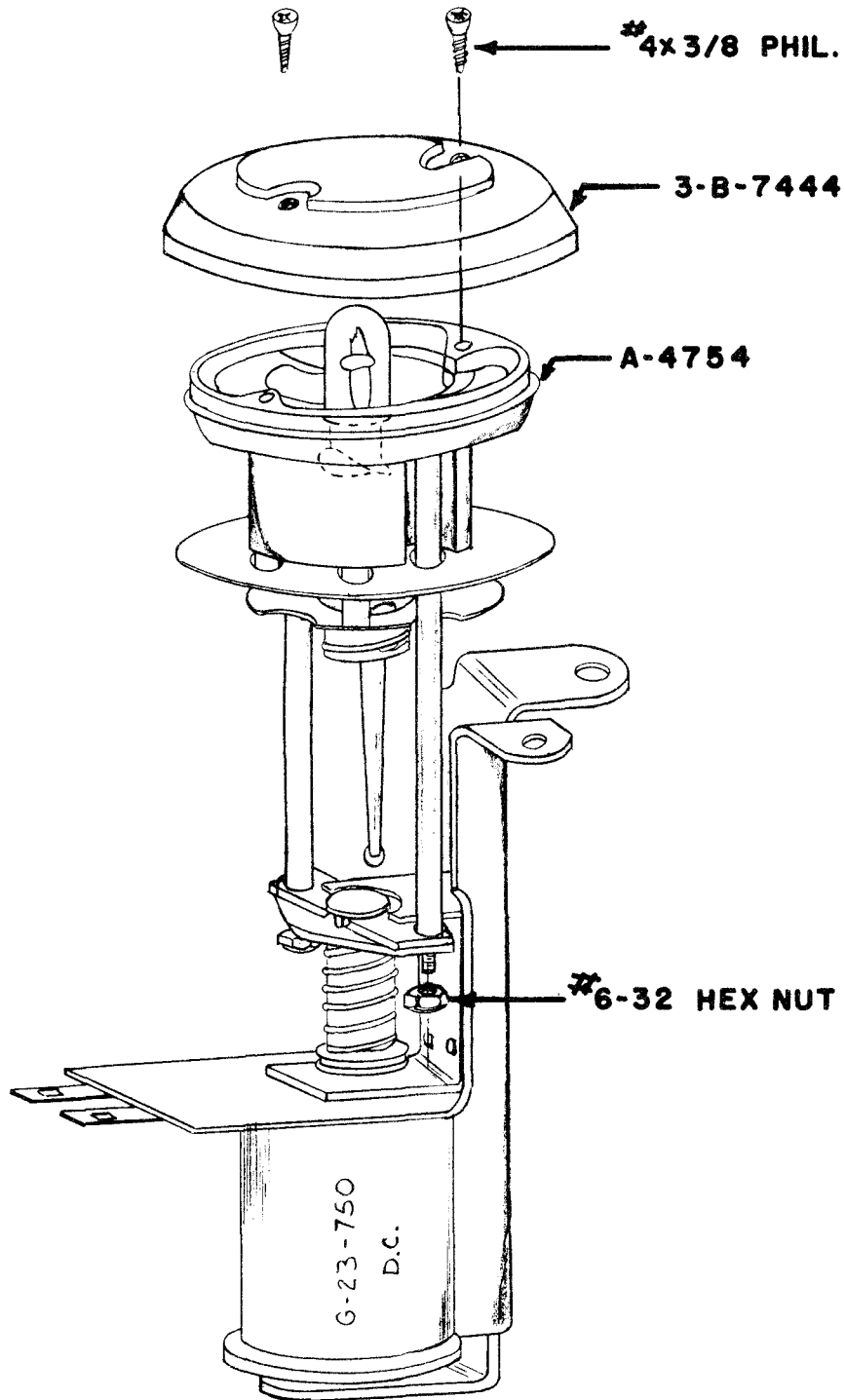

**TO EASILY REPLACE METAL RING ASS'Y**

- 1. REMOVE (2) 4X3/8 PHILLIPS SCREWS.**
- 2. REMOVE BUMPER CAP (3-B-7444).**
- 3. REMOVE (2) #6-32 HEX ELASTIC STOP NUTS.**
- 4. PULL METAL RING ASS'Y (A-4754) UP AND OUT.**
- 5. REPLACE METAL RING ASS'Y, NUTS, BUMPER CAP, AND SCREWS.**

# ADJUSTMENTS ON MECHANISM PANEL

## 10¢ Adjustment

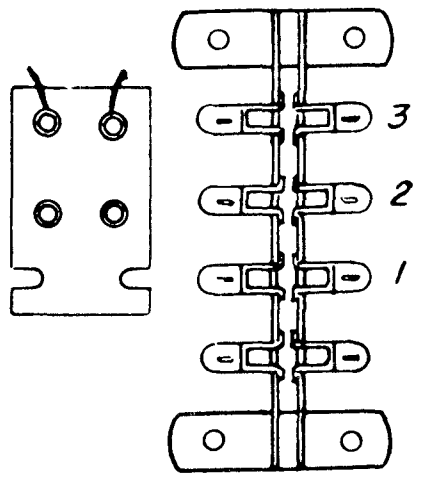

PROVIDES  
1, 2 OR  
3 PLAYS  
FOR ONE  
COIN.

## 5¢ Adjustment

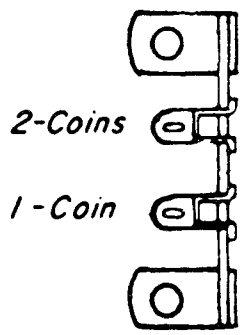

IN "2 COINS FOR  
1 PLAY", CIRCUIT  
TO COIN RELAY  
PASSES THRU SW.  
ON ALTERNATOR  
UNIT.

## 25¢ Adjustment

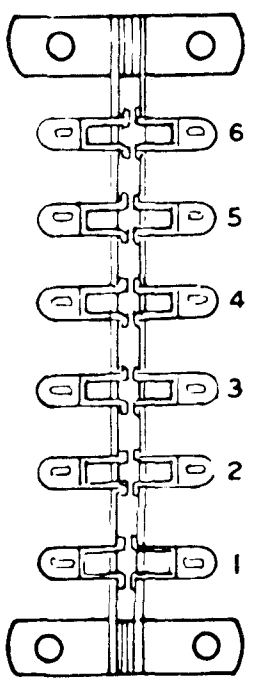

PROVIDES 1, 2, 3, 4, 5  
OR 6 PLAYS FOR 25¢.

## Motor Service Jack

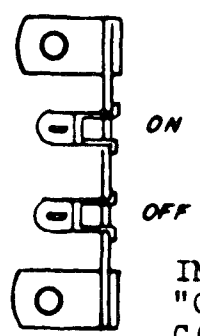

INSERT PHONE TIP IN  
"OFF" POSITION - CAMS  
CAN BE TURNED BY HAND  
TO CHECK ADJUSTMENT OF  
SWITCHES.

## MASTER ON-OFF SW.

(Located under front of  
Cabinet)

1 COIN- 1 PLAY  
2 COINS- 3 PLAYS

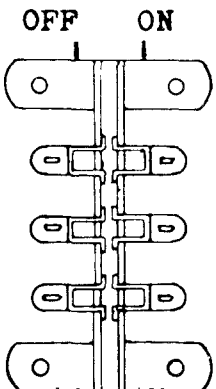

IN "ON" POSITION, 10¢  
ADJUSTMENT MUST BE IN #2 PO-  
SITION & 25¢ ADJUSTMENT MUST  
BE IN #6 POSITION. FIRST  
COIN ADVANCES CREDIT UNIT 1  
STEP. SECOND COIN WILL AD-  
VANCE CREDIT UNIT 2 STEPS.  
IN "OFF" POSITION, 25¢  
ADJUSTMENT AND/OR 10¢ AD-  
JUSTMENT SHOULD BE PUT IN  
PROPER POSITION.

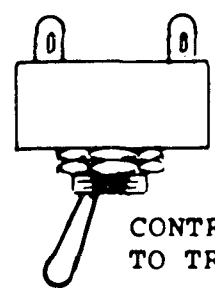

CONTROLS POWER  
TO TRANSFORMER

# ADJUSTMENTS IN BACKBOX

## Hi-Score Adjustment

PLUG IN PURPLE WIRE FOR SCORES  
101,000 TO 110,000  
3 BALL OR 5 BALL

1000

6000

PLUG IN RED WIRE FOR SCORES  
111,000 TO 120,000

2000

7000

PLUG IN BLUE WIRE FOR SCORES  
121,000 TO 130,000

3000

8000

PLUG IN YELLOW WIRE FOR SCORES  
131,000 TO 140,000

4000

9000

PLUG IN GREEN WIRE FOR SCORES  
141,000 TO 150,000

5000

0000

ADJUSTMENT RANGE FROM  
101,000 TO 199,000

PLUG IN WHITE WIRE FOR SCORES  
151,000 TO 160,000

PLUG IN BROWN WIRE FOR SCORES  
161,000 TO 170,000

PLUG IN ORANGE WIRE FOR SCORES  
171,000 TO 180,000

PLUG IN BLACK WIRE FOR SCORES  
181,000 TO 190,000

PLUG IN GRAY WIRE FOR SCORES  
191,000 TO 199,000

EXAMPLE: BLUE WIRE INTO 1,000 POSITION SCORES AT 121,000

## PLAY ADJUSTMENT

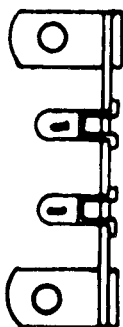

CREDIT

EXTRA BALL

IN CREDIT POSITION: HI-SCORES & LEFT OR RIGHT BOTTOM ROLLOVER, WHEN LIT FOR "SPECIAL", WILL SCORE A CREDIT.

IN EXTRA BALL POSITION, THE ABOVE WILL PULSE EX. BALL RE.

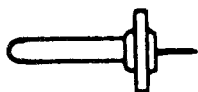

## NUMBER MATCH ADJUSTMENT

ON OFF

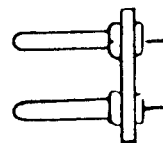
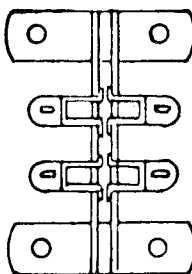

IN "ON" POSITION, A CREDIT IS SCORED IF LAST TWO DIGITS IN POINT SCORE ARE IDENTICAL TO NUMBER MATCH LIFE. IN "OFF" POSITION, NUMBER MATCH IS INOPERATIVE.

## No. of Balls Adjustment

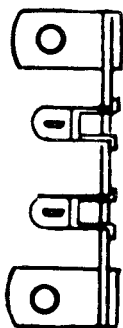

5 BALL

3 BALL



Plug changes 3 to 5 ball play, or vice versa.

## SUGGESTED SCORE CARDS

### REPLAY

5 BALL...464-32

3 BALL...464-10

### EXTRA BALL

5 BALL...464-51

3 BALL...464-46

ADJUSTMENTS ON PLAYFIELD

# SPINNER & EXTRA BALL ADJ.

LIB.  
MED.  
CONS.

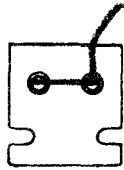
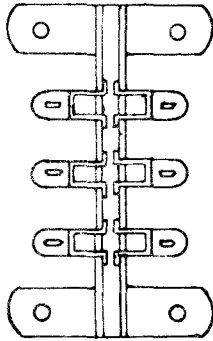

THERE ARE 10 LITES BY THE SWINGING TARGET; 2 ARE AMBER, 1 IS YELLOW & 1 IS GREEN.

IN LIBERAL POSITION, THE "SET-UP" RELAY WILL REMAIN ENERGIZED WHEN ANY OF THE FOUR ARE LIT.

IN MEDIUM POSITION, THE SET-UP RELAY WILL REMAIN ENERGIZED WHEN THE TWO AMBER OR THE YELLOW IS LIT.

IN CONSERVATIVE POSITION, THE SET-UP RELAY WILL STAY ENERGIZED ONLY WHEN THE TWO AMBER LITES ARE LIT.

THE SET-UP RELAY CONTROLS THE "SPINNER 1,000 POINTS" LITE AND THE TOP CENTER "EXTRA BALL" LITE.

## ADVANCE BONUS ADJ.

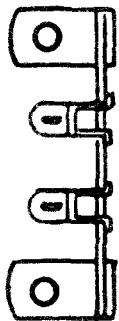

1000

100



GAME SCORES 100 OR 1,000 POINTS EACH TIME ADVANCE RELAY IS PULSED.

## SUPER ADVANCE ADJ.



LIB.

CONS.



IN LIBERAL POSITION, THE ADVANCE RELAY IS PULSED 5 TIMES.  
IN CONSERVATIVE POSITION, THE ADVANCE RELAY IS PULSED 3 TIMES.

## SEQUENCE OF OPERATION

### RESET CYCLE

CREDIT UNIT RESET COIL IS ENERGIZED BY SWITCH ON RESET RELAY, THRU SCORE MOTOR INDEX CAM SWITCH A, CREDIT BUTTON, ZERO SWITCH ON CREDIT UNIT, AND SWITCH ON GAME-OVER RELAY OR COIN UNIT LAST POSITION BREAK SWITCH.

END-OF-STROKE SWITCH ON CREDIT UNIT RESET COIL WILL ENERGIZE COIN RELAY.

SWITCHES ON COIN RELAY WILL RUN SCORE MOTOR, TRIP GAME-OVER RELAY, AND ENERGIZE RESET RELAY.

SWITCHES ON RESET RELAY WILL OPEN CIRCUITS TO PLAYFIELD SWITCHES AND OUTHOLE RELAY, RUN SCORE MOTOR, ENERGIZE RESET COILS ON COIN UNIT-BALL COUNT UNIT-PLAYER UNIT AND GAME OVER RELAY, PULSE 1 & 2 AND 3 & 4 RESET RELAYS, AND ENERGIZE BONUS RELAY.

SWITCHES ON 1 & 2 AND 3 & 4 RESET RELAYS, WILL PULSE THE (16) SCORING DRUM UNITS UNTIL THEY REACH ZERO.

SWITCHES ON BONUS RELAY WILL RUN SCORE MOTOR, HOLD RESET RELAY IN AND PULSE BONUS UNIT RESET COIL, (BONUS RELAY IS HELD IN BY ZERO SWITCH ON BONUS UNIT).

WHEN BONUS RELAY DROPS OUT, OUTHOLE RELAY IS ENERGIZED THRU ZERO SWITCH ON BONUS UNIT AND INDEX CAM SWITCH D.

SWITCHES ON OUTHOLE RELAY WILL RUN SCORE MOTOR, PULSE BONUS UNIT S.U. COIL, AND PULSE BALL RELEASE COIL TO PROPEL BALL TOWARD PLUNGER.

---

### SPACE MISSION

GAME OPERATES AS FOLLOWS:

TWO TOP ROLLOVER LANES, WHEN LIT, AND SWINGING TARGET SCORE SWINGING TARGET VALUE. THESE VALUES ARE EITHER 1,000 OR 5,000 POINTS AND WHEN SO INDICATED ALSO LIGHT EITHER A, B OR C.

WHEN EITHER A, B OR C IS MADE, IT LIGHTS EJECT HOLES.

SPINNER LIGHTS FOR 1,000 POINTS WHEN YELLOW, GREEN OR ONE OF TWO AMBER LIGHTS ON SWINGING TARGET IS LIT (ADJUSTABLE).

WHEN EITHER A, B OR C IS MADE AND YELLOW, GREEN OR ONE OF TWO AMBER LIGHTS ON SWINGING TARGET IS LIT, IT LIGHTS TOP CENTER ROLLOVER LANE FOR EXTRA BALL (ADJUSTABLE).

WHEN A, B OR C ARE MADE, TWO BOTTOM OUT ROLLOVER LANES LIGHT ALTERNATELY FOR SPECIAL.

## **I. GENERAL**

NEVER EXPERIMENT with any of the mechanism. Locate any trouble with the aid of Wiring Diagrams or Operating & Servicing Information supplied with the machine, then check for proper adjustment of the units involved before making any changes. Improper adjustment or make-shift repair will only cause serious damage to other parts of the machine or repeated failure of the part.

NOTE: Always look for a possible loose wire, bad connection at a plug and socket, broken or unhooked springs on step-up units, relays, etc., before adjustments are made or wires reconnected.

## **2. FUSES**

IMPORTANT: Never replace fuses with any rating other than specified on the fuse block; this block is located adjacent to the transformer.

## **3. LUBRICATION**

Over-lubrication causes far more trouble in coin operated equipment than under-lubrication. Practically all cases of poor contact on switches and wiper discs are due to oil or grease, or oil vapor, which forms a film or residue on the contacts and will not allow current to pass through. Excess lubricant may also seep into clutches causing them to slip.

IMPORTANT: NEVER USE VASELINE FOR LUBRICATION OF ANY PART OF THE MACHINE. Vaseline is not a true lubricant. It leaves a dirty and gummy residue and it becomes very thick when cold. A special Coin Machine Lubricant is supplied with each machine.

STEP-UP Levers, Ratchets, Cams, Shafts and other sliding or oscillating parts should be very lightly greased with special Coin Machine Lubricant (supplied with machine) not oftener than every six months. The bakelite discs (biscuits) on the Motor Units and Step-up Units will require lubrication with the special Coin Machine Lubricant only after the grease is completely evaporated (3 to 12 months, depending on climate) or when the film of grease becomes dirty. In either event, clean the parts thoroughly with a solvent, then apply an extremely thin coat of the special grease.

Solenoid Plungers should not have a lubricant of any kind. Should there be a sluggish tendency or if plungers are sticking, the parts should be cleaned with a solvent and flaked graphite applied on reassembly.

## **SWITCH ADJUSTMENT**

BEFORE ADJUSTING SWITCHES, MAKE CERTAIN THE SCREWS HOLDING THE SWITCH STACKS ARE DOWN TIGHTLY. BAKELITE SPACERS IN THE SWITCH STACKS, DUE TO EXCESSIVE MOISTURE, HAVE OCCASIONALLY SHRUNK BY DRYING OUT, CAUSING POOR ADJUSTMENT.



# INSTRUCTIONS FOR COIN TRIP SWITCH ADJUSTMENT

WIRE SHOULD BE IN CONTACT WITH END OF CRESCENT OPENING WHEN BLADE ADJUSTMENT IS MADE.

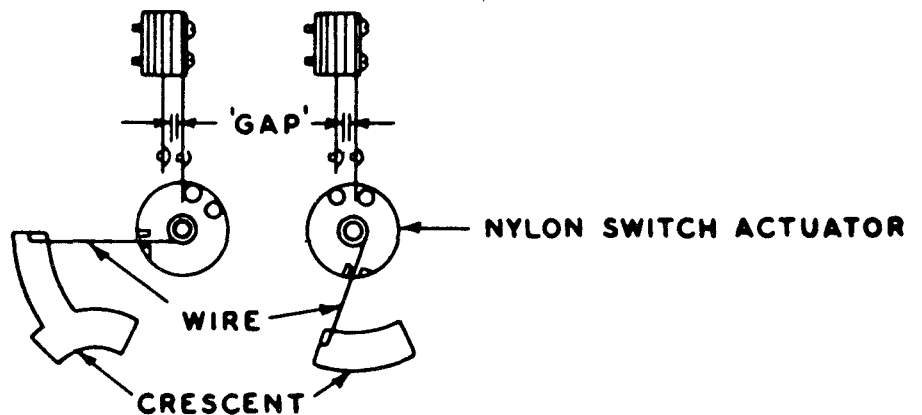

Long blade should be in contact with nylon switch actuator and have a maximum overtravel of 1/32.

or

Using a gram gauge, tension of long blade should not exceed 10 grams.

## SWITCH ADJUSTMENT

1. For small coins, such as dimes, adjust short blade so that the 'gap' between the silver contacts is .045 to .055.
2. For larger & heavier coins the 'gap' should be .045 to .060.
3. Do not adjust 'gap' closer than .040.

---

### POWER TRANSFORMER:

LOCATED ON MECHANISM PANEL, IT IS EQUIPPED WITH A SECONDARY TAP. IF YOUR GAME IS ON LOCATION WITH EXTREMELY LOW LINE VOLTAGE, REMOVE LEAD FROM LUG MARKED 24 VOLTS AND SOLDER TO ALTERNATE LUG MARKED "HIGH". THIS WILL BOOST SECONDARY VOLTAGE APPROXIMATELY 2-3 VOLTS.

### LEG LEVELERS:

ARE PROVIDED FOR TWO PURPOSES - 1ST TO LEVEL GAME ON LOCATION, 2ND TO INCREASE PITCH FOR GAME PERCENTAGING. IF IT IS DESIRED TO SPEED UP PLAY AND DECREASE SCORES, RAISE REAR LEG LEVELERS TO INCREASE PITCH.

## **CAUTION!**

The playboard on this machine has an improved finish with excellent wearing properties. Do not under any circumstances clean the board with water, water soap solutions or harsh abrasives. Avoid such things as steel wool, kitchen cleansers or abrasive hand soap. Water will weaken the adhering of the paint to the board and abrasives shorten the board life by many thousand plays. A wax base cleaner with negligible abrasive qualities used lightly, but frequently, will extend the board life to its full capabilities.

---

## **SERVICEMAN TO REMOVE BACKGLASS:**

- **WITH BACK DOOR REMOVED, PULL BACK ON BRACKETS AT INSIDE TOP OF LITE BOX.**
- **FROM THE FRONT OF GAME, LIFT GLASS UP AND OUT.**

# **IMPORTANT NOTICE**

**KINDLY INFORM LOCATIONS THAT THEY  
CAN TURN DISPLAY LIGHTS ON BY FLIPPING  
MASTER SWITCH ON.**

**MASTER SWITCH (ON-OFF) IS LOCATED  
UNDERNEATH FRONT PART OF CABINET.**

## SILICON BRIDGE RECTIFIER

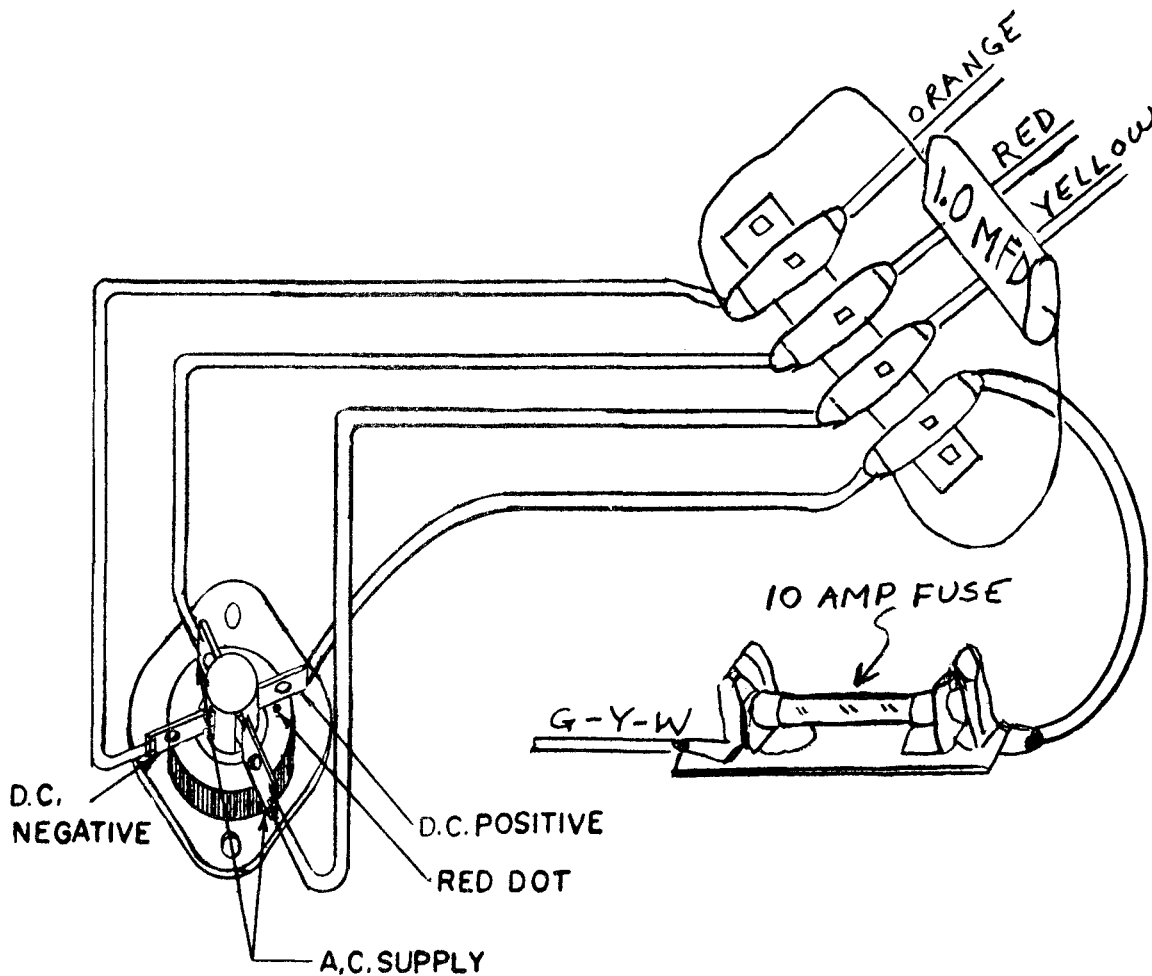

THE FUNCTION OF THE RECTIFIER AND CAPACITOR IS TO CONVERT THE ALTERNATING CURRENT (A.C.) TO DIRECT CURRENT (D.C.), SUPPLYING D.C. TO THE BUMPERS, KICKERS ETC.

THE BRIDGE RECTIFIER SHOULD PRACTICALLY NEVER NEED REPLACING, AS IT IS RATED WELL OVER THE VOLTAGE AND CURRENT REQUIREMENTS OF THE COMPONENTS IT SUPPLIES.

IF, HOWEVER, THE 15 AMP 24 VOLT FUSE ON THE MECHANISM PANEL OPENS, IT COULD BE DUE TO A FAULTY RECTIFIER. DISCONNECT THE A.C. INPUT TO RECTIFIER, REPLACE FUSE, AND RECHECK.

IF THE 10 AMP FUSE LOCATED NEXT TO THE RECTIFIER OPENS, CHECK ALL D.C. COMPONENTS I.E. BUMPERS, KICKERS ETC. FOR SHORTS.

# WARRANTY

THE MOTORS IN ALL NEW WILLIAMS PRODUCTS  
ARE UN-CONDITIONALLY GUARANTEED FOR  
6 MONTHS FROM DATE OF PURCHASE.

ANY DEFECTIVE MOTORS RETURNED DURING THE  
WARRANTY PERIOD WILL BE REPLACED FREE OF  
CHARGE BY YOUR WILLIAMS DISTRIBUTOR.

## IMPORTANT NOTICE

WHEN ORDERING PARTS ALWAYS SPECIFY NAME OF  
UNIT, GAME AND SERIAL NUMBER, IN ADDITION TO A  
CLEAR DESCRIPTION OF THE PART AND PART  
NUMBER IF POSSIBLE.

### UNIT PARTS LIST

UNIT NAME	CONTACT DISC	WIPER ASSEMBLY	RATCHET GEAR ASSEMBLY	MOTORS
REPLAY BALL COUNT	----- C-6414	----- B-7456-6	A-6400 A-6402-5	
(RIGHT SIDE)	B-7568	A-7614		
NO. MATCH (LEFT SIDE)	B-7569	A-7615	A-7548-1	SCORE MOTOR
PLAYER	C-6417	C-6521	A-6404-3	14A-7883 (60 CYCLE)
COIN	C-6414	B-7456-9	A-6402-3	
BONUS	C-6417	B-7456-59	A-6402-20	14A-7884 (50 CYCLE)
SWINGING TAR.	C-6417	B-7456-60	A-6401	
10 POINT	B-7253	A-6294	3C-7272	
100 POINT	-----	-----	3C-7272	
1000 POINT	B-7253	A-6294	3C-7272	
10000 POINT	B-7253	A-6294	3C-7272	
ALTERNATOR	-----	-----	3C-7272	

# SPACE MISSION

## POST ADJUSTMENT SHEET

TO MAKE GAME MORE "CONSERVATIVE" OR "LIBERAL"-MOVE POST 3/16" AS SHOWN IN SKETCH BELOW. SPOTTING HOLES ARE PROVIDED AND CAN BE SEEN ON REMOVAL OF POSTS.

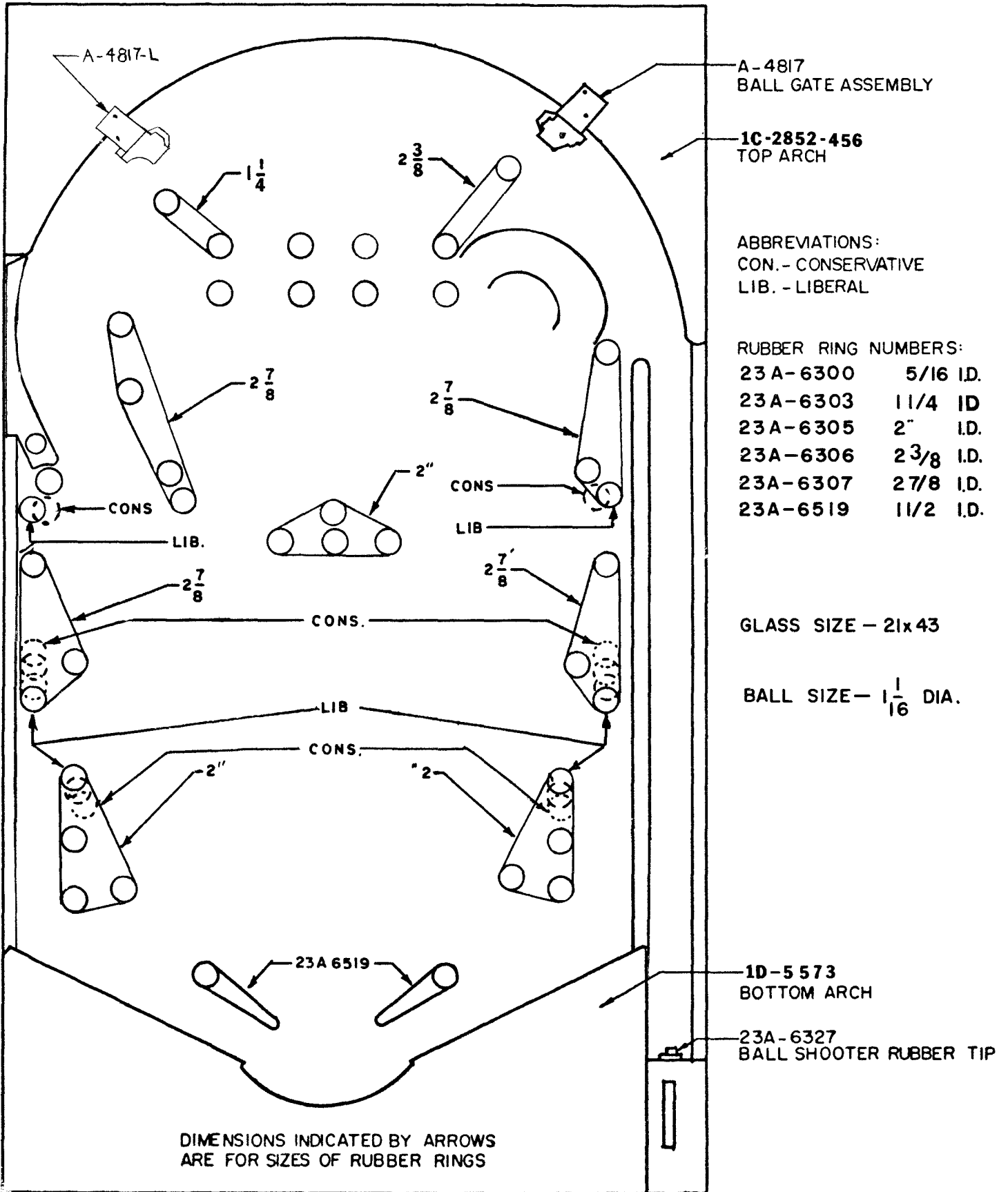

A-4817  
BALL GATE ASSEMBLY

1C-2852-456  
TOP ARCH

ABBREVIATIONS:  
CON. - CONSERVATIVE  
LIB. - LIBERAL

RUBBER RING NUMBERS:

23A-6300	5/16 I.D.
23A-6303	1 1/4 ID
23A-6305	2" I.D.
23A-6306	2 3/8 I.D.
23A-6307	2 7/8 I.D.
23A-6519	1 1/2 I.D.

GLASS SIZE - 21x43

BALL SIZE - 1 1/16 DIA.

1D-5573  
BOTTOM ARCH

23A-6327  
BALL SHOOTER RUBBER TIP

## NOTICE:

THIS GAME OPERATES ON 24 VOLTS. WHEN ORDERING REPLACEMENT TRANSFORMERS, MOTORS, COILS OR METERS ... MAKE SURE TO SPECIFY CORRECT PART NUMBER.

NUMBER	DESCRIPTION	LOCATION
<u>MOTORS &amp; TRANSFORMERS</u>		
14 A-7745	SWINGING TARGET MOTOR - 50 OR 60 CYCLE	PLAYFIELD
14 A-7883	CONTROL MOTOR - 60 CYCLE	MECH. PANEL
14 A-7884	CONTROL MOTOR - 50 CYCLE	MECH. PANEL
15 A-6771	TRANSFORMER - 60 CYCLE	MECH. PANEL
15 A-6782-1	TRANSFORMER - 50 CYCLE	MECH. PANEL
B 6396	24 VOLT METER	MECH. PANEL
<u>SOLENOID COILS</u>		
A 22-550	COIN UNIT STEP UP SWINGING TARGET UNIT STEP UP BONUS UNIT STEP UP BALL RELEASE COIL PLAYER UNIT STEP UP	MECH. PANEL PLAYFIELD PLAYFIELD PLAYFIELD INSERT
A 23-600	BALL COUNT UNIT STEP UP CREDIT UNIT STEP UP	MECH. PANEL INSERT
A2-23-750	KNOCKER	CABINET
A2-26-1300	TRIPLE CHIMES COILS ... (3 req'd.)	CABINET
B1-26-800	SCORE DRUM UNITS ... (16 req'd.) CREDIT UNIT RESET PLAYER UNIT RESET BALL COUNT UNIT RESET COIN UNIT RESET BONUS UNIT RESET	INSERT INSERT INSERT MECH. PANEL MECH. PANEL PLAYFIELD
FL 21-375/ 28-400	FLIPPERS ... (2 req'd.)	PLAYFIELD
G 22-500	SHOOTER COILS... (2 req'd.)	PLAYFIELD
G 23-750	EJECT COILS... (2 req'd.)	PLAYFIELD
G 23-750 D.C.	D.C. JET BUMPER COILS ... (2 req'd.)	PLAYFIELD
M 29-900	100,000 RELAYS TRIP ... (4 req'd.) 1 - 2 RESET RELAY 3 - 4 RESET RELAY	INSERT INSERT INSERT
M 28-700	GAME OVER RELAY TRIP	MECH. PANEL
M 29-1100	10¢ RELAY 25¢ RELAY 10 POINT RELAY 100 POINT RELAY 1,000 POINT RELAY 100,000 RELAYS LATCH ... (4 req'd.) 50 POINT RELAY ADVANCE RELAY SHOOTER RELAY EJECT RELAY 5,000 RELAY SWINGING TARGET RELAY SUPER ADVANCE RELAY	MECH. PANEL MECH. PANEL INSERT INSERT INSERT INSERT INSERT PLAYFIELD PLAYFIELD PLAYFIELD PLAYFIELD PLAYFIELD PLAYFIELD PLAYFIELD PLAYFIELD
M 30-1300	COIN SET UP RELAY SET UP RELAY	MECH. PANEL PLAYFIELD
M1-31-1500	COIN LOCKOUT RELAY	FRONT DOOR
XM 27-675	TOTAL PLAY METER COIL	CABINET
XS 28-1000	ALTERNATOR UNIT NUMBER MATCH UNIT	MECH. PANEL INSERT
Z 27-1000	COIN RELAY RESET RELAY PLAYER RESET RELAY OUTHOLE RELAY GAME OVER RELAY LATCH BONUS RELAY	MECH. PANEL MECH. PANEL MECH. PANEL MECH. PANEL MECH. PANEL MECH. PANEL PLAYFIELD
Z 28-1150	CHANGE RELAY "A" RELAY "B" RELAY "C" RELAY DOUBLE BONUS RELAY BALL INDEX RELAY TILT RELAY EXTRA BALL RELAY	PLAYFIELD PLAYFIELD PLAYFIELD PLAYFIELD PLAYFIELD MECH. PANEL MECH. PANEL MECH. PANEL
Z 29-1250	LOCK RELAY	MECH. PANEL

# JACK LAYOUT

GAME SPACE MISSION

POSITION PAN.-PLAYF. SIZE 20

# JACK LAYOUT

GAME SPACE MISSION

POSITION PAN.-PLAYF. SIZE 16

FEED	BⒶ		1
"	RⒶ		2
MOTOR	0/G		3
RESET RE.	BLU /BR		4
EJECT COILS	G/W-3		5
BONUS U. RESET	0/O-4		6
" "	0/W-1		7
SUPER ADV. RE.	BR/B		8
FEED	YⒶ		9
SWINGING TARGET RE.	BR/R		10
<u>Ⓐ = 16 GAUGE</u>			

	GRY/BLU-4 BONUS RE.		
	GRY/G-4 " "		
	R/B-4 " "		
	B/BLU-1 OUTHOLERE.		
	GRY/Y-2 BONUS U. STEP UP		
	BLU/W-4 BALL RELEASE		
	Y/R-2 TILT RE.		
	W/BR-4 "		
	Y/BLU-4 SHOOT AGAIN LITE		
	W/B-7 TILT RE.		
	PL. = PLASTIC		

	SWINGING TARGET MOTOR	B PL.	1	R-Y-WⒶ FEED
	" "	BLU PL.	2	G/B-2 DOUBLE BONUS RE.
	EXT. BALL RE.	Y/B-5	3	0/BLU-1 50 PT. RE.
	1.00 OPT. RE.	B/BLU-3	4	GRY/W ADVANCE RE.
	" "	GRY/BR-3	5	B/W-5Ⓐ L.FLIPPER
	" "	W/G-6	6	BR/W-5Ⓐ R. "
	EJECT RE.	R/BR	7	BLUⒶ FEED
	COIN SET UP RE.	GRY/BLU-2	8	-



# JACK LAYOUT

GAME SPACE MISSION

POSITION PANEL-INSERT SIZE 24

FEED	B@
FEED	R@
COIN LOCKOUT	B/R-4
CREDIT UNIT RESET	W/O
" "	W/BLU
RESET RE.	BLU/W-1
KNOCKER	B/W
RESET RE.	BLU/BR-1
BALL COUNT U. STEP UP	BLU/R-1
NO.1 BALLITE	W/B-5
FEED	BR@
3-4 RESET RE.	B/BLU

# JACK LAYOUT

GAME SPACE MISSION

POSITION PANEL-INSERT SIZE 20

NO.3 BALLITE	GRY/Y-1
1ST. PLAYER MATCH	BLU-2
2ND. " "	R/BR-2
3RD. " "	BR/O
4TH. " "	BR/Y-5
CREDIT U.S.U.	GRY/B-2
M.CHIME	O-2
TILT LITE	BLU/B-2
BALL IND. RE.	BR/G-4
COIN RE.	G/W

1	GRY/W-3	I-CAN PLAY
2	Y/G-1	2- " "
3	O/W	3- " "
4	O/R-3	4- " "
5	R/W	BALL COUNT U.S.U.
6	BLU/R-4	GAME OVER RE. TRIP
7	BLU/Y-5	" "
8	G-	NO. MATCH UNIT STEP U.
9	GRY/G-2	NO.4 BALLITE
10	GRY/BR-2	NO.5 " "

# JACK LAYOUT

GAME SPACE MISSION

POSITION PANEL-INSERT SIZE 12

# JACK LAYOUT

GAME SPACE MISSION

POSITION PLAYE.-INSERT SIZE 10

1	FEEED TO D.U. W/O-5
2	CREDIT U.S.U. B/W-1
3	COIN RE. R/BR
4	CREDIT U.S.U. GRY/BR
5	—
6	—

1	CREDIT LITE GRY/Y-3
2	SHOOT AGAIN W/LITE G-4
3	BALL IND. RE. GRY/R-2
4	CHANGERE. B/R-1
5	—

BR/Y 1.000 PT. RE.
W/R 100 PT. RE.
G/B 10 PT. RE.
B/W-1 CREDIT ADJ. JACK
—

BLU/Y-3 PLAYER LITES
GRY/O-1 G.OVER LITE
BLU/BR-4 G.OVER RETRIP
Y/B-5 EXT. BALL RE.
—
—

# BALL COUNT UNIT DISC

THIS UNIT RESETS AT THE START OF A NEW GAME, (DURING RESET CYCLE). IT ADVANCES ONE STEP EACH TIME THE LAST PLAYER COMPLETES HIS TURN.

View looking at WIPER FINGER side with WIPER in ZERO position.

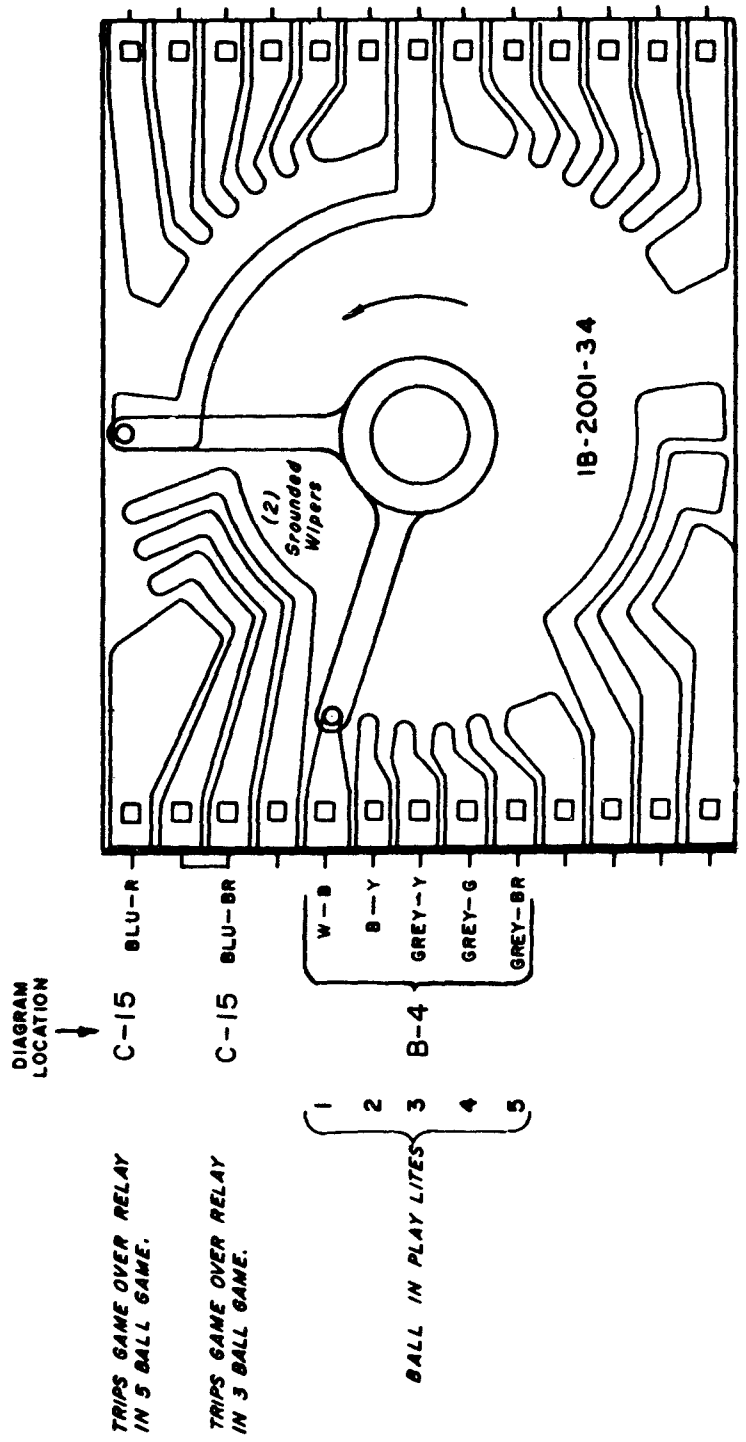

# COIN S. U. DISC

THIS UNIT RESETS AT START OF A GAME (DURING RESET CYCLE). IT THEN ADVANCES ONE STEP EACH TIME THE COIN RELAY IS PULSED.

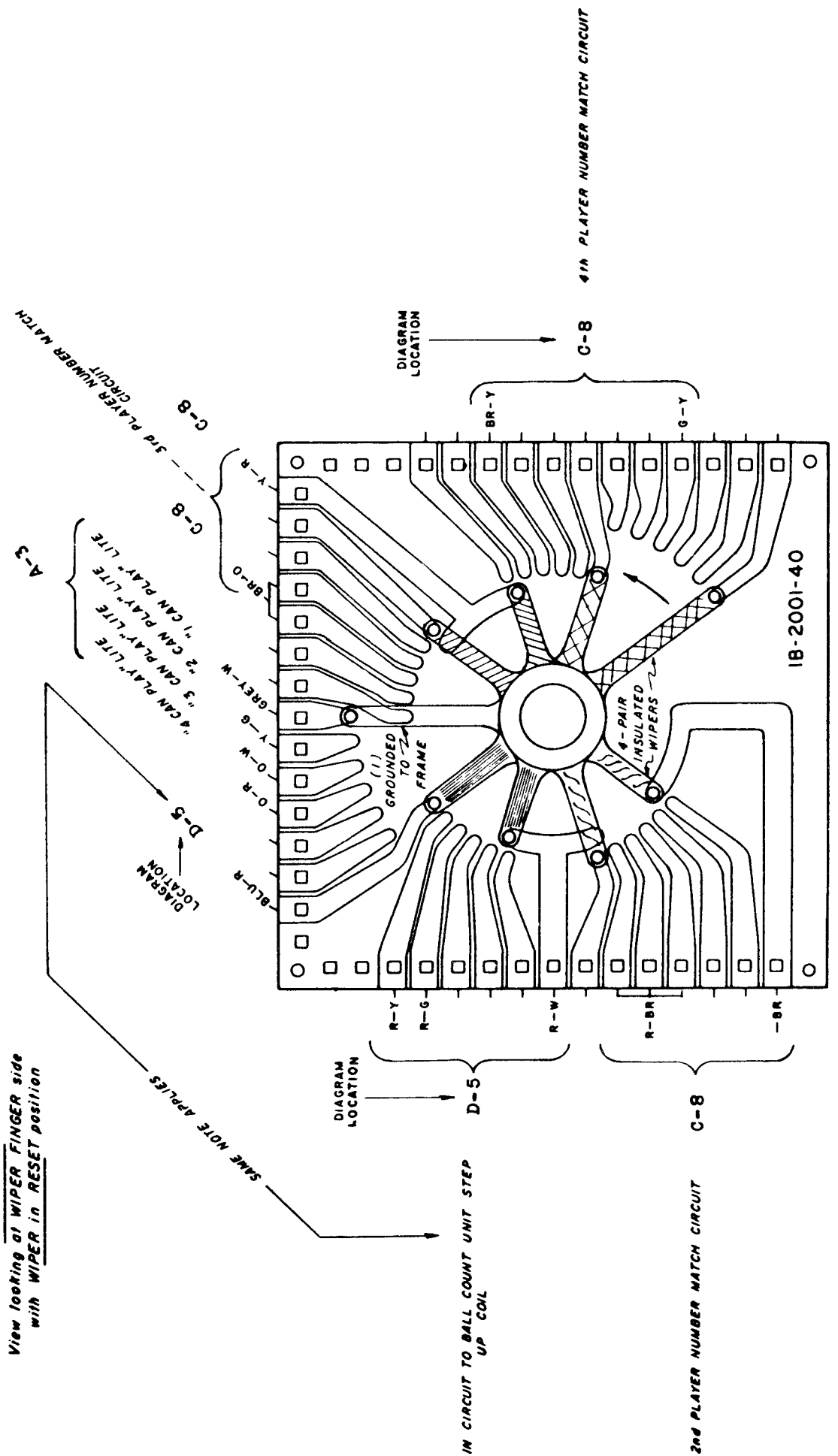

View looking at WIPER FINGER side with WIPER in RESET position

# PLAYER UNIT DISC

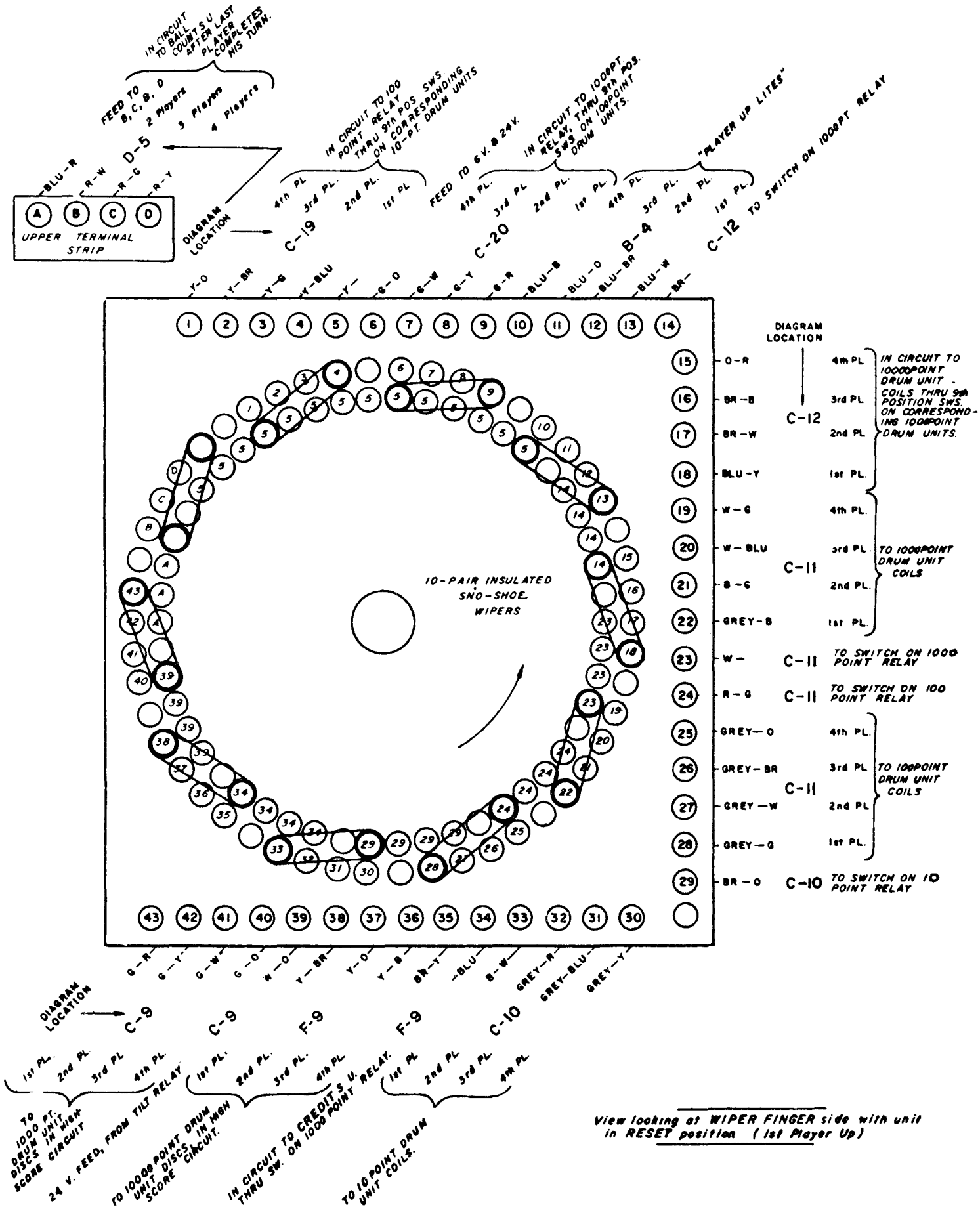

View looking at WIPER FINGER side with unit in RESET position (1st Player Up)

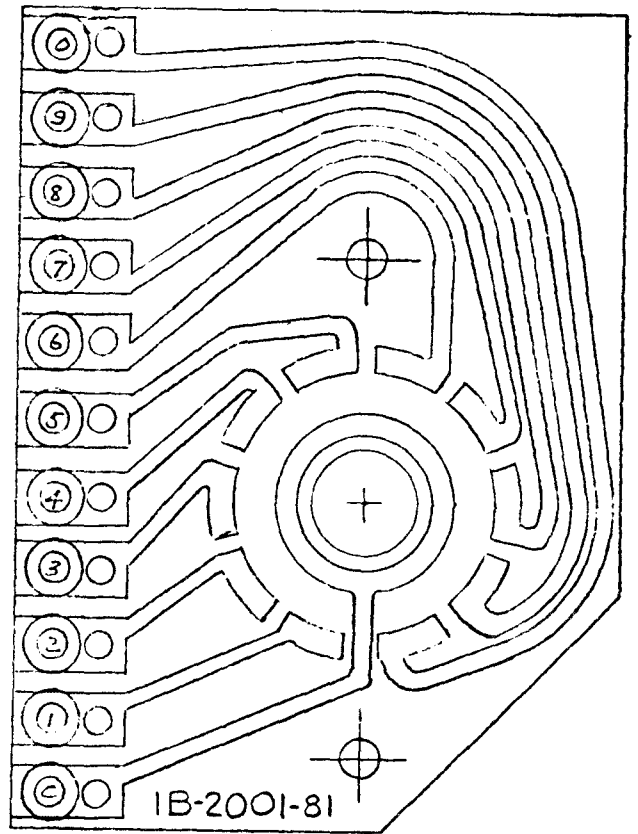
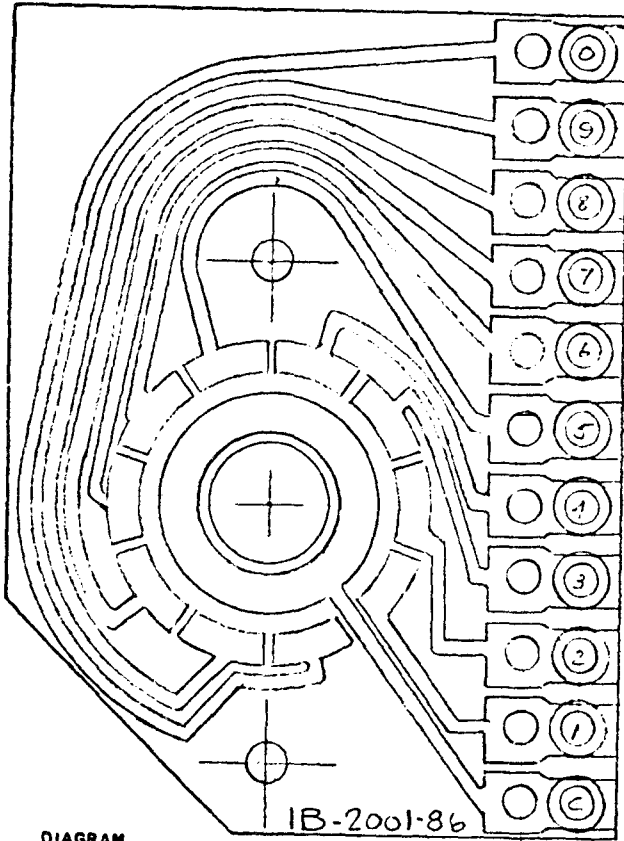

DIAGRAM LOCATION

**No. MATCH UNIT**

B-5

00 LITE W/G-3	0
60 " BR/W-4	9
10 " BR/G-3	8
70 " BR/Y-2	7
30 " BR/BLU-2	6
80 " BR/R-2	5
20 " W/GRY-3	4
50 " W/B-3	3
90 " W/O-3	2
40 " W/BR-5	1
FEED Y-	C

PRINTED CIRCUIT- IB-2001-86

PRINTED CIRCUIT- IB-2001-81

Y/BLU	00-MATCH
G/Y-3	60 "
Y/G	10 "
G/W-2	70 "
Y/O	30 "
G/O-2	80 "
Y/BR-2	20 "
G/R-1	50 "
W/BLU-2	90 "
Y/B-1	40 "
GRY/R-4	FEED

E-8

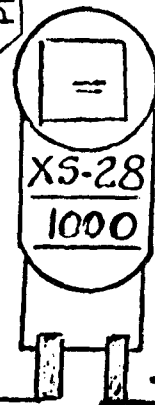

DRIVE SPRING 10A-324-1

## BONUS UNIT

THIS UNIT STEPS UP WHEN THE ADVANCE RELAY OR SWINGING TARGET RELAY IS ENERGIZED.

ALSO, AFTER THIS UNIT HAS BEEN RESET TO ZERO, THE STEP-UP COIL IS ENERGIZED ONCE BY SCORE MOTOR CAM SWITCH 3A, THRU SWITCH ON OUTHOLE RELAY.

THE RESET COIL IS ENERGIZED BY BONUS RELAY, THRU DOUBLE BONUS RELAY AND SCORE MOTOR CAM SWITCH 3D OR 5B AND IMPULSE CAM SWITCH C.

1000	B-10	R-BLU	
2000		R-Y	
3000		G-B	
4000		R-BR	
5000		G-R	
6000		R-B	
7000		BLU-R	
8000		BLU-Y	
9000		BLU-W	
10000		BLU-BR	
20000	B-11	B-O	
CIRCUIT TO BALL INDEX RELAY.		GRAY-R	

*View looking at WIPER FINGER side  
with WIPER in ZERO position.*

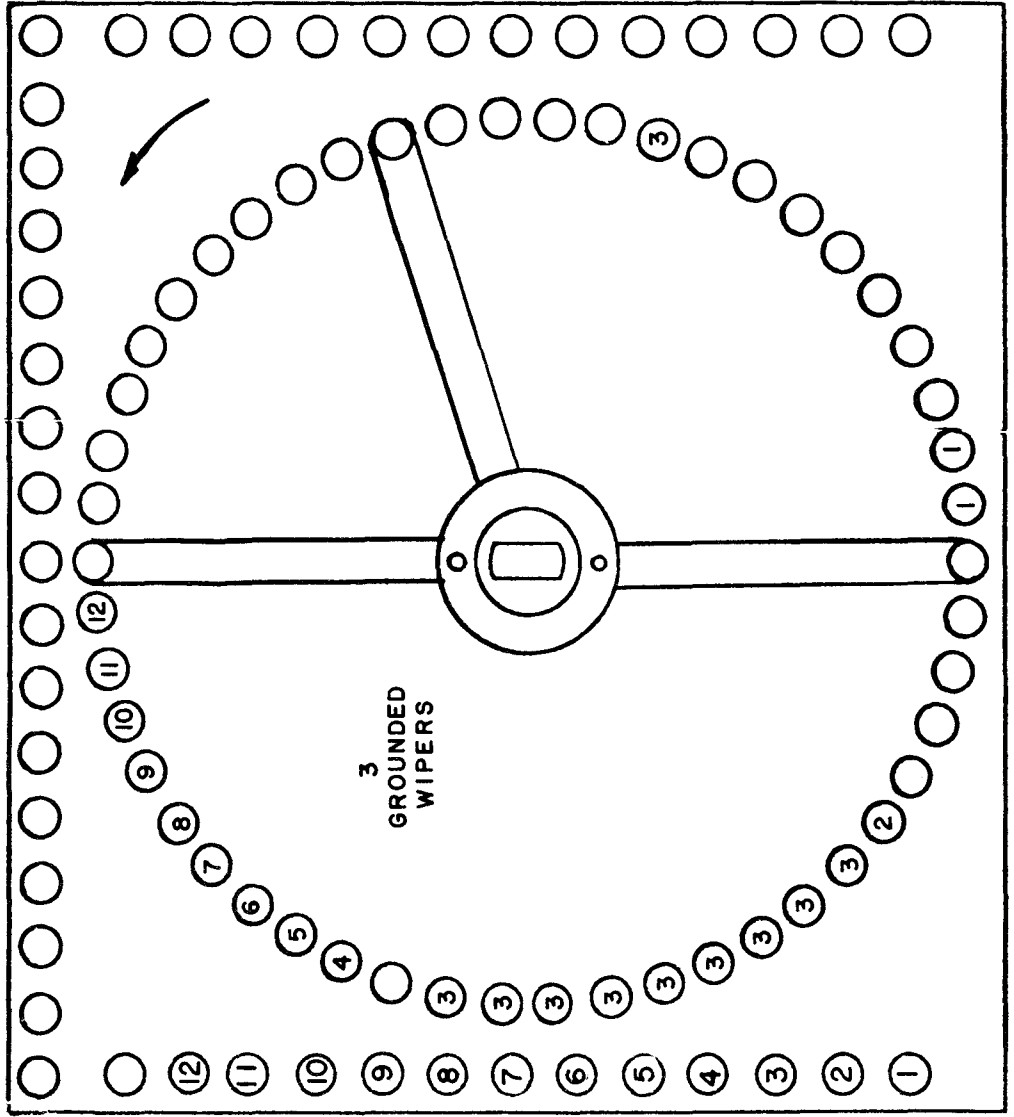

## SWINGING TARGET UNIT

THIS UNIT STEPS UP WHEN THE SWINGING TARGET RELAY IS ENERGIZED.  
THIS UNIT DOES NOT HAVE A RESET COIL.

VIEW LOOKING AT  
WIPER FINGER SIDE

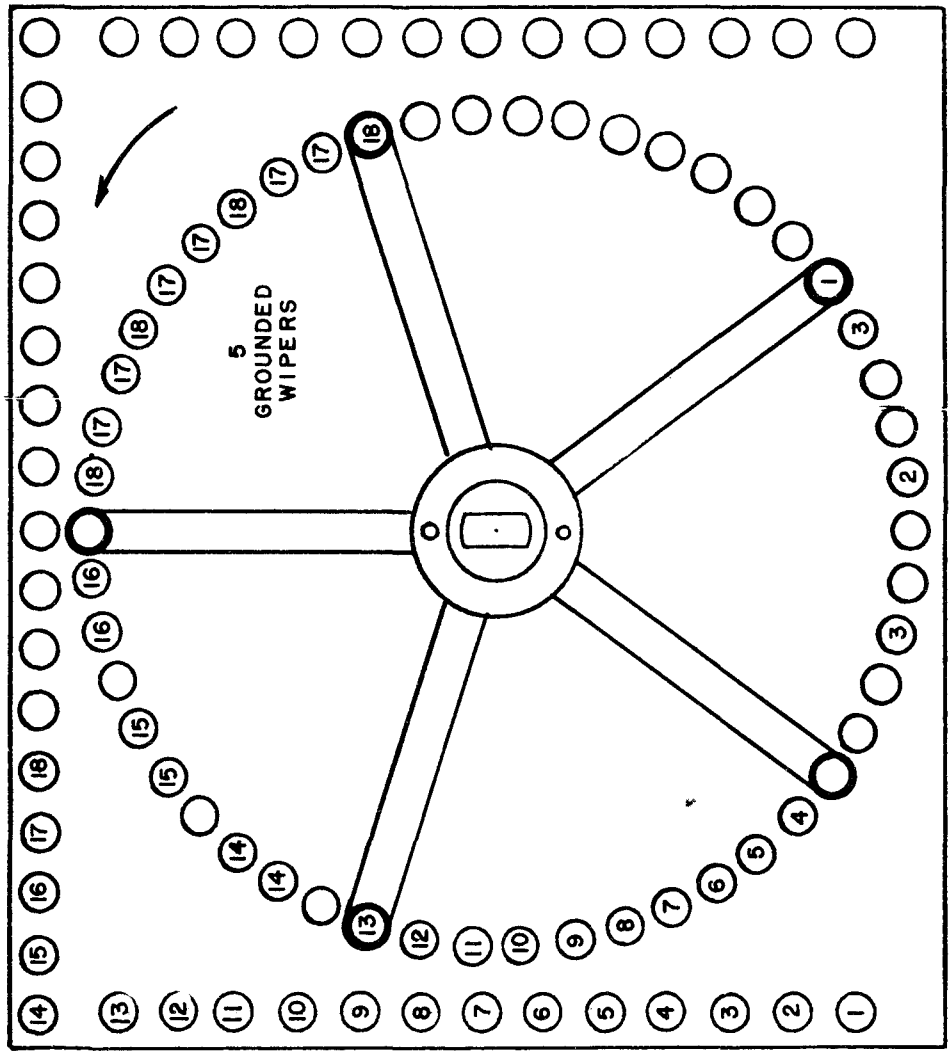
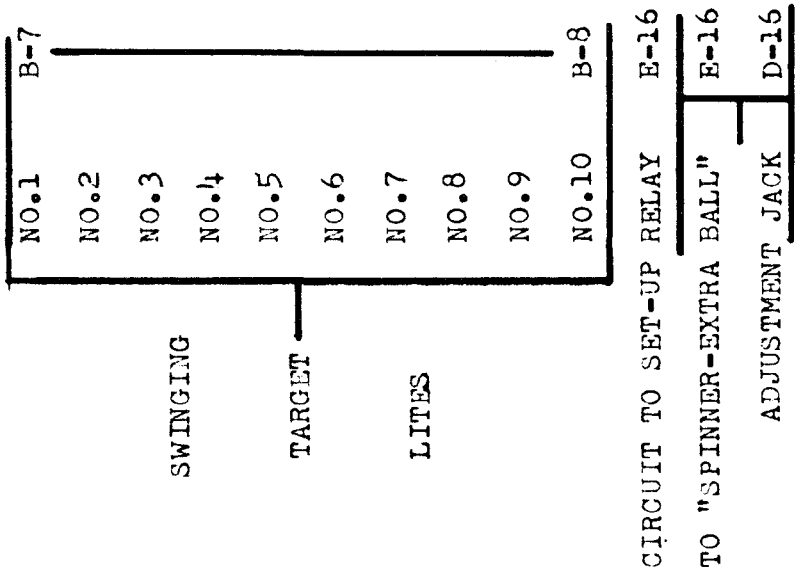

W-B  
B-Y  
GRAY-Y  
GRAY-G  
GRAY-BR  
GRAY-O  
Y-O  
W-R  
R-B  
G-B  
GRAY-O  
W-R  
O-W

GRAY-W  
O-B  
GRAY-M  
O-3LU  
E-16  
D-16  
D-16  
C-21  
C-21  
CIRCUIT TO "A" RELAY.  
CIRCUIT TO "B" RELAY.  
CIRCUIT TO "C" RELAY.  
CIRCUIT TO 5000 RELAY.  
CIRCUIT TO 1000 P1. RELAY.



# RELAYS & SWITCHES LOCATED ON MECHANISM PANEL

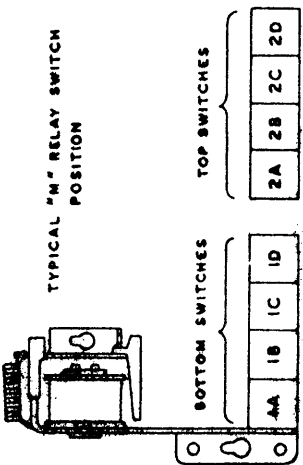

## TILT

IS ENERGIZED BY PLUMB BOB TILT, BALL ROLL DOWN TILT OR PLAYFIELD VIBRATION TILT SWITCH ... ALSO BY SPINNER LANE ROLLOVER SWITCH, THRU BALL INDEX RELAY.

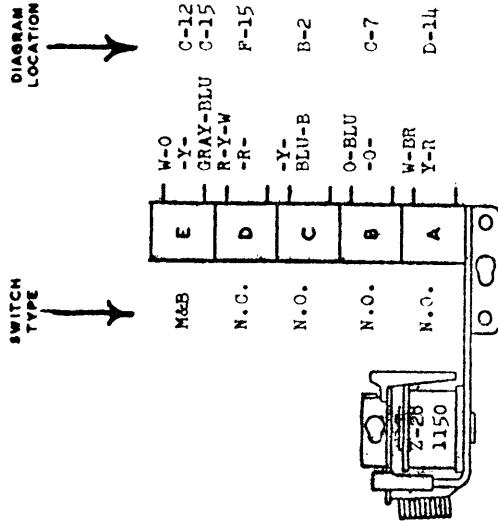

OPENS IN HI-SCORE CIRCUITS AND ALL (16) SCORE DRUM COILS, AND CLOSSES TO ENERGIZE BALL INDEX RELAY.

OPENS CIRCUITS TO MOST PLAYFIELD SWITCHES.

TO "TILT" LITE.

IN SERIES WITH SWITCH 'A' ON COIN SET-UP RELAY.

HOLD CIRCUIT TO THIS RELAY, THRU SWITCH ON OUTHOLE RELAY.

## EXTRA BALL

IS ENERGIZED BY TOP CENTER ROLLOVER SWITCH, THRU SET-UP RELAY AND EITHER 'A', 'B' OR 'C' RELAY.

ALSO, WITH PLAY ADJUSTMENT JACK IN "EXTRA BALL" POSITION, BY LEFT OR RIGHT BOTTOM ROLLOVER WHEN LIT FOR SPECIAL... AND BY HIGH SCORE CIRCUITS.

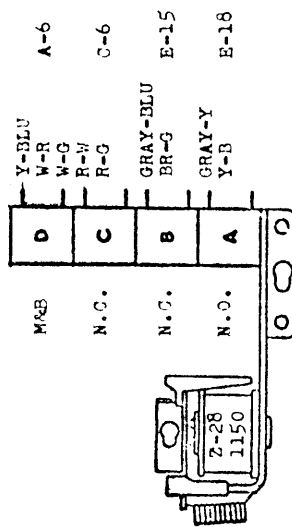

OPENS IN HOLD CIRCUIT TO COIN SET-UP RELAY.

RUNS SCORE MOTOR.

PULSES CREDIT UNIT S.U. COIL, THRU IMPULSE CAM SWITCH B.

IN HOLD CIRCUIT TO THIS RELAY.

## 10¢

IS ENERGIZED BY 10¢ COIN SWITCH, IF 10¢ ADJUSTMENT JACK IS IN "2 PLAYS" OR "3 PLAYS" POSITION ... ALSO BY 25¢ COIN SWITCH, THRU SWITCH ON COIN SET-UP RELAY IF "2 COINS FOR 3 PLAYS" ADJUSTMENT IS IN "ON" POSITION.

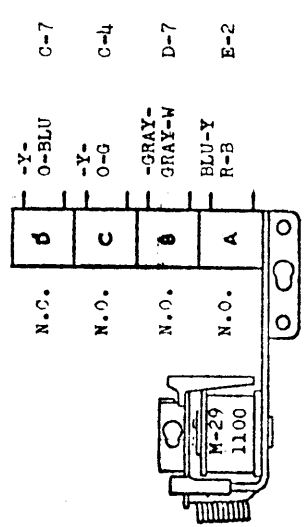

OPENS IN CIRCUIT TO TOP CENTER ROLLOVER LITE, AND CLOSSES TO 'SHOOT AGAIN' LITES.

IN SERIES WITH SWITCH 'B' ON BALL INDEX RELAY.

IN CIRCUIT TO BALL INDEX RELAY.

IN HOLD CIRCUIT TO THIS RELAY.

## 25¢

IS ENERGIZED BY 25¢ COIN SWITCH.

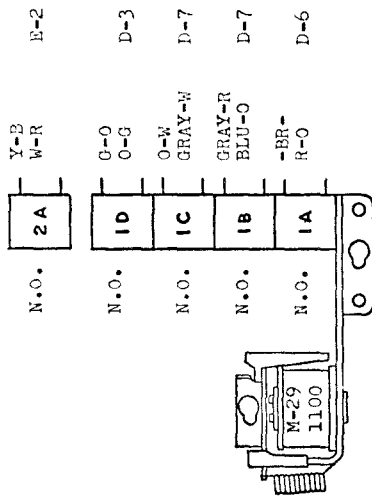

## COIN SET-UP

IS ENERGIZED BY 25¢ RELAY, ONLY IF "2 COINS FOR 3 PLAYS" ADJUSTMENT IS IN "ON" POSITION.

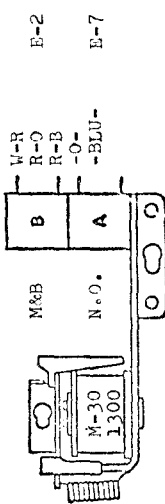

## GAME-OVER

LATCH COIL IS ENERGIZED BY SCORE MOTOR CAM SWITCH 1B, THRU SWITCHES ON COIN RELAY AND RESET RELAY.  
TRIP COIL IS ENERGIZED BY COIN RELAY, THRU A ZERO SWITCH ON PLAYER UNIT OR BALL COUNT UNIT ... ALSO BY LOCK RELAY OR WIPER FINGER ON BALL COUNT UNIT DISC.

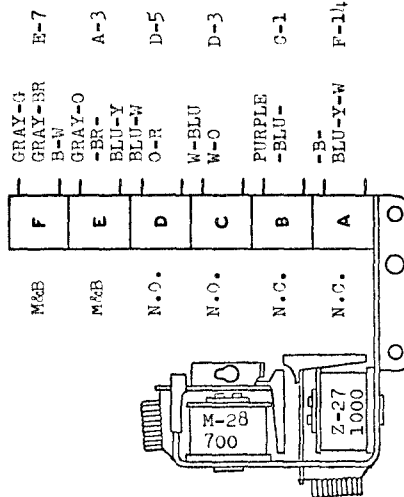

## BALL INDEX

IS ENERGIZED BY 10 POINT, 100 POINT OR 1,000 POINT RELAY, THRU WIPER FINGER ON BONUS UNIT DISC ... ALSO TRY TILT RELAY.

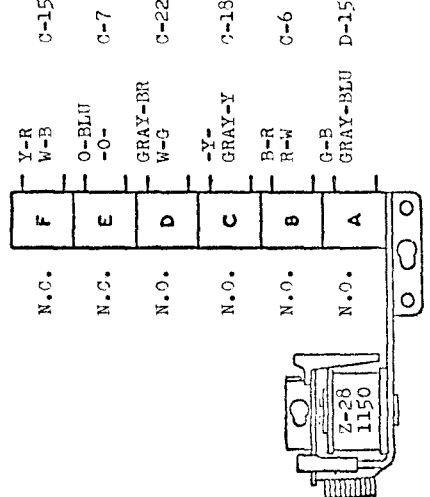

IN HOLD CIRCUIT TO THIS RELAY.

RUNS SCORE MOTOR, THRU 25¢ COIN SWITCH.

PULSES CREDIT UNIT S.U. COIL, THRU "2 COINS FOR 3 PLAYS" ADJUSTMENT JACK.

PULSES CREDIT UNIT S.U. OR COIN RELAY, THRU "2 COINS FOR 3 PLAYS" ADJUSTMENT JACK.

ENERGIZES COIN SET-UP RELAY, THRU "2 COINS FOR 3 PLAYS" ADJUSTMENT JACK.

OPENS TO 25¢ RELAY AND CLOSURES TO 10¢ RELAY.

IN HOLD CIRCUIT TO THIS RELAY.

OPENS IN HI-SCORE CIRCUITS AND CLOSURES IN NUMBER MATCH CIRCUITS TO "CREDIT-EXTRA BALL" ADJUSTMENT.

OPENS TO "PLAYER UP" AND "BALL IN PLAY" LITES, & CLOSURES TO NO. MATCH AND GAME-OVER LITES.

IN CIRCUIT TO RESET RELAY, THRU SWITCH ON COIN RELAY.

IN CIRCUIT TO CREDIT UNIT RESET COIL.

OPENS CIRCUIT TO SWINGING TARGET MOTOR (115 VOLTS).

OPENS CIRCUITS TO PLAYFIELD SWITCHES.

IN CIRCUIT TO TILT RELAY, THRU SPINNER LANE ROLLOVER SWITCH.

IN SERIES WITH SWITCH 'A' ON COIN SET-UP RELAY.

IN CIRCUIT TO PULSE 1,000 POINT RELAY (WHEN COLLECTING BONUS).

IN HOLD CIRCUIT TO EXTRA BALL RELAY.

IN CIRCUIT TO BALL COUNT S.U. COIL---ALSO IN SERIES WITH SWITCH 'C' ON PLAYER RESET RELAY.

IN HOLD CIRCUIT TO THIS RELAY.

## OUTHOLE

IS ENERGIZED BY ZERO SWITCH ON BONUS UNIT, THRU SWITCH ON BONUS RELAY.

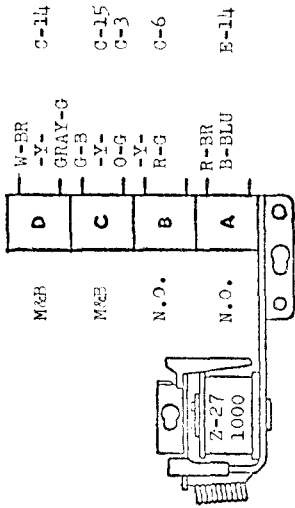

C-14 OPENS IN HOLD CIRCUIT TO TILT RELAY, AND CLOSSES TO PULSE BONUS UNIT S.U. COIL AND BALL RELEASE COIL.

C-15 OPENS IN HOLD CIRCUIT TO 'A', 'B', 'C', DOUBLE BONUS AND BALL INDEX RELAYS, AND CLOSSES TO RUN SCORE MOTOR.

C-3 IN SERIES WITH SWITCH 'C' ON EXTRA BALL RELAY.

C-6 IN HOLD CIRCUIT TO THIS RELAY.

E-14

## PLAYER RESET

IS ENERGIZED BY BALL COUNT UNIT END-OF-STROKE SWITCH. IT THEN HOLDS IN THRU SCORE MOTOR INDEX CAM SWITCH B.

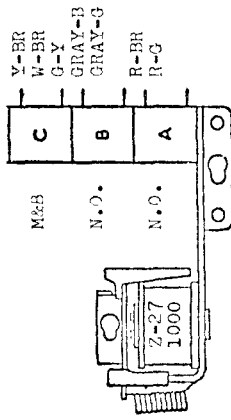

D-6 OPENS IN CIRCUIT TO PLAYER UNIT S.U. COIL AND CLOSSES TO PLAYER UNIT RESET COIL.

E-3 IN NO. MATCH CIRCUIT TO CREDIT UNIT S.U. OR EXTRA BALL RELAY.

C-6 HOLD CIRCUIT TO THIS RELAY, THRU SCORE MOTOR INDEX CAM SWITCH 'B'.

## RESET

IS ENERGIZED BY COIN RELAY, THRU SWITCH ON GAME-OVER RELAY.

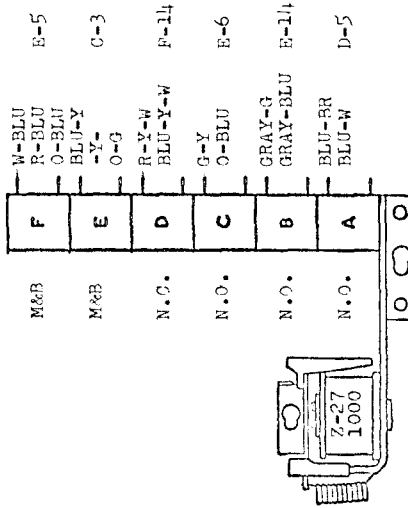

E-5 OPENS IN CIRCUIT TO COIN UNIT S.U. COIL AND CLOSSES TO RESET COILS ON COIN, BALL COUNT AND GAME-OVER.

C-3 OPENS CIRCUIT TO CREDIT UNIT RESET COIL AND CLOSSES TO RUN SCORE MOTOR.

F-14 OPENS CIRCUITS TO MOST PLAYFIELD SWITCHES.

E-6 IN CIRCUIT TO PLAYER UNIT RESET COIL.

E-14 ENERGIZES BONUS RELAY, THRU ZERO SWITCH ON BONUS UNIT.

D-5 IN HOLD CIRCUIT TO THIS RELAY.

## COIN

IS ENERGIZED BY COIN SWITCH OR CREDIT UNIT RESET COIL END-OF-STROKE SWITCH... ALSO BY 5¢ COIN SWITCH, THRU SWITCH ON ALTERNATOR UNIT... ALSO BY 25¢ RELAY IF GAME IS ADJUSTED TO "1 PLAY FOR 25¢" OR "6 PLAYS FOR 25¢".

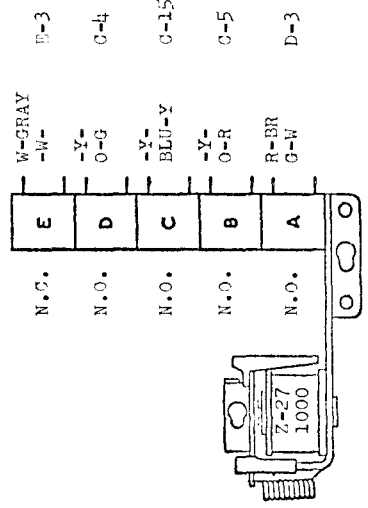

E-3 OPENS CIRCUIT TO COIN LOCKOUT COIL.

C-4 RUNS SCORE MOTOR.

C-15 ENERGIZES GAME-OVER RELAY TRIP COIL, THRU BALL COUNT UNIT OR PLAYER UNIT ZERO SWITCHES.

C-5 ENERGIZES RESET RELAY, THRU SWITCH ON GAME-OVER RELAY.

D-3 IN HOLD CIRCUIT TO THIS RELAY.

## LOCK

IS ENERGIZED WHEN POWER IS SUPPLIED TO TRANSFORMER.

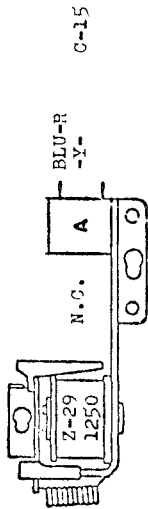

ENERGIZES GAME-OVER RELAY TRIP COIL.

## BONUS

IS ENERGIZED BY RESET RELAY OR OUTHOLE SWITCH.

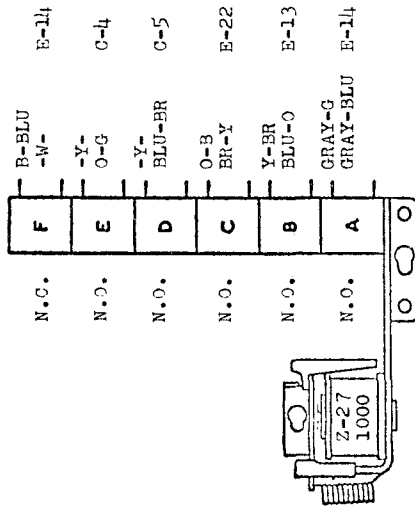

IN CIRCUIT TO OUTHOLE RELAY.

RUNS SCORE MOTOR.

IN HOLD CIRCUIT TO RESET RELAY.

IN CIRCUIT TO 1,000 POINT RELAY. (WHEN COLLECTING BONUS).

IN CIRCUIT TO BONUS UNIT RESET COIL.

HOLD CIRCUIT TO THIS RELAY, THRU ZERO SWITCH ON BONUS UNIT.

## DOUBLE BONUS

IS ENERGIZED BY EJECT RELAY, THRU 'A', 'B' OR 'C' RELAY.

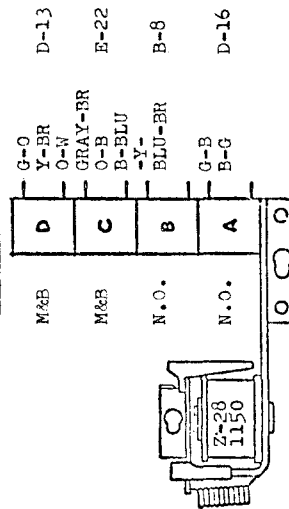

IN SERIES WITH SWITCH 'B' ON BONUS RELAY.

IN SERIES WITH SWITCH C ON BONUS RELAY.

TO "DOUBLE BONUS" LITE.

HOLD CIRCUIT TO THIS RELAY, THRU SWITCH ON OUTHOLE RELAY.

## "A"

IS ENERGIZED BY SWINGING TARGET RELAY, THRU WIPER ON SWINGING TARGET UNIT DISC.

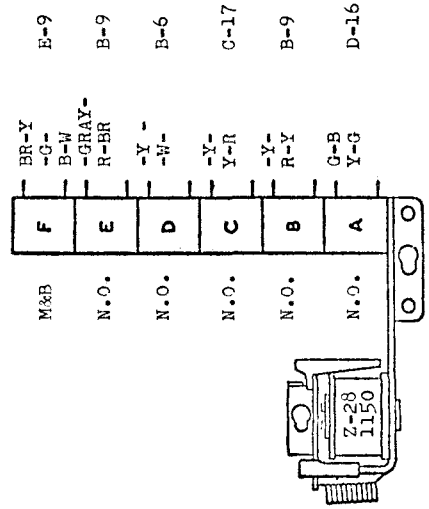

OPENS IN CIRCUIT TO 1,000 POINT RELAY AND CLOSES TO CREDIT UNIT S.U. OR EXTRA BALL RELAY.

IN SERIES WITH SWITCH 'E' ON 'C' RELAY.

TO (2) EJECT LITES---ALSO IN CIRCUIT TO TOP CENTER ROLLOVER LITE.

IN CIRCUIT TO DOUBLE BONUS RELAY AND EXTRA BALL RELAY.

TO 'A' SWINGING TARGET LITE.

IN HOLD CIRCUIT TO THIS RELAY.

## "B"

IS ENERGIZED BY SWINGING TARGET RELAY,  
THRU WIPER ON SWINGING TARGET UNIT  
DISC.

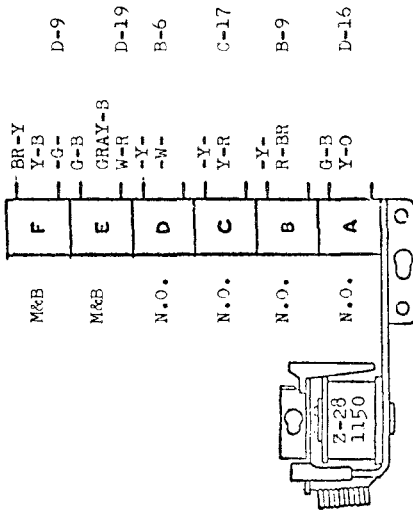

D-9 OPENS IN CIRCUIT TO 1,000 POINT RELAY AND CLOSES TO CREDIT UNIT S.U. OR EXTRA BALL RELAY.

D-19 OPENS IN CIRCUIT TO 10 POINT RELAY AND CLOSES TO 100 POINT RELAY.

B-6 IN PARALLEL WITH SWITCH 'D' ON 'A' RELAY.

C-17 IN CIRCUIT TO DOUBLE BONUS RELAY AND EXTRA BALL RELAY.

B-9 TO 'B' SWINGING TARGET LITE.

D-16 IN HOLD CIRCUIT TO THIS RELAY.

## "C"

IS ENERGIZED BY SWINGING TARGET RELAY,  
THRU WIPER ON SWINGING TARGET UNIT  
DISC.

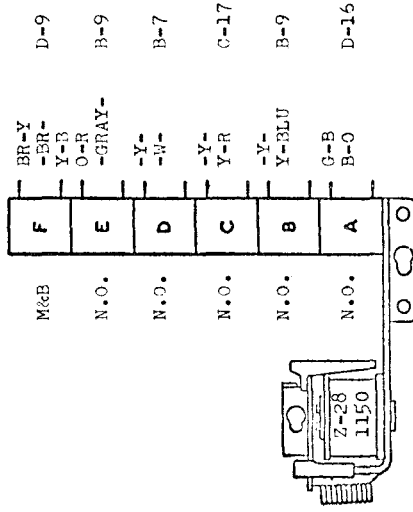

D-9 OPENS IN CIRCUIT TO 1,000 POINT RELAY, AND CLOSES TO CREDIT UNIT S.U. OR EXTRA BALL RELAY.

B-9 IN SERIES WITH SWITCH 'D' ON CHANGE RELAY.

B-7 IN PARALLEL WITH SWITCH 'D' ON 'B' RELAY.

C-17 IN CIRCUIT TO DOUBLE BONUS RELAY AND EXTRA BALL RELAY.

B-9 TO 'C' SWINGING TARGET LITE.

D-16 IN HOLD CIRCUIT TO THIS RELAY.

## CHANGE

IS ENERGIZED BY NUMBER MATCH UNIT  
ALTERNATOR SWITCH.

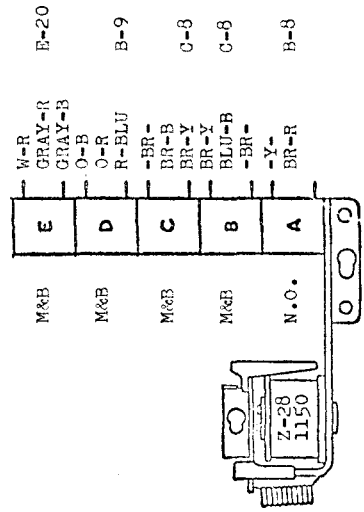

E-20 OPENS IN CIRCUIT TO 100 POINT RELAY AND CLOSES TO SWINGING TARGET RELAY.

B-9 OPENS TO RIGHT BOTTOM ROLLOVER LITE (SPECIAL) AND CLOSES TO LEFT BOTTOM ROLLOVER LITE (SPECIAL).

C-3 IN CIRCUIT TO 1,000 POINT RELAY, OR CREDIT UNIT S.U. OR EXTRA BALL RELAY.

C-6 IN CIRCUIT TO 1,000 POINT RELAY, OR CREDIT UNIT S.U. OR EXTRA BALL RELAY.

B-8 TO LEFT & RIGHT TOP ROLLOVER LITES.

## ADVANCE

IS PULSED BY:

1. LEFT OR RIGHT TOP TARGET SWITCH.
2. SPINNER LANE ROLLOVER SWITCH.
3. CENTER TOP ROLLOVER SWITCH.
4. SUPER ADVANCE RELAY.

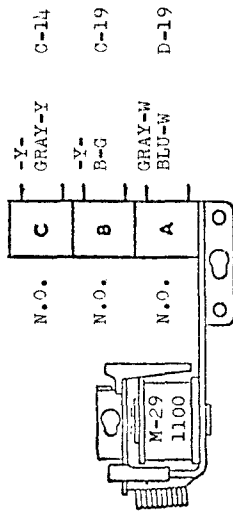

C-14 ENERGIZES STEP-UP COIL ON BONUS UNIT.

C-19 IN CIRCUIT TO 100 POINT OR 1,000 POINT RELAY (THRU ADVANCE BONUS ADJUSTMENT JACK).

D-19 HOLD CIRCUIT TO THIS RELAY, THRU BONUS UNIT END-OF-STROKE SWITCH.

## SUPER ADVANCE

IS ENERGIZED BY SUPER ADVANCE ROLLOVER BUTTON SWITCH (TOP RIGHT OF PLAYFIELD).

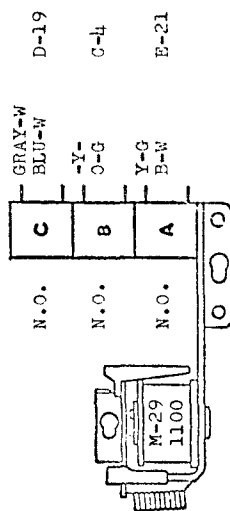

D-19 PULSES ADVANCE RELAY.

C-4 RUNS SCORE MOTOR.

E-21 IN HOLD CIRCUIT TO THIS RELAY. (THRU SUPER ADVANCE ADJUSTMENT JACK).

## SWINGING TARGET

IS ENERGIZED BY SWINGING TARGET SWITCH OR BY LEFT AND RIGHT TOP ROLLOVER SWITCH, THRU CHANGE RELAY.

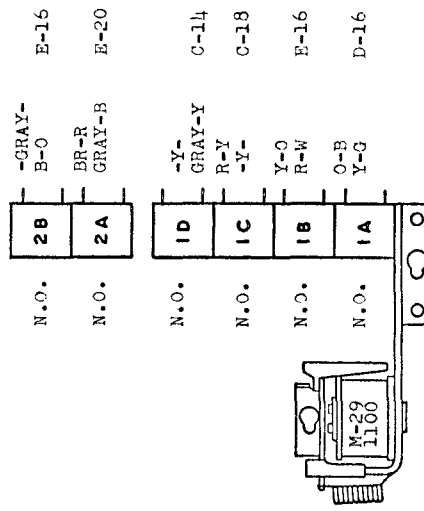

E-16 ENERGIZES 'C' RELAY, THRU SWINGING TARGET UNIT DISC.

E-20 IN HOLD CIRCUIT TO THIS RELAY.

C-14 ENERGIZES BONUS UNIT S.U. COIL.

C-18 PULSES SWINGING TARGET UNIT S.U. COIL.

E-16 ENERGIZES 'B' RELAY, THRU SWINGING TARGET UNIT DISC.

D-16 ENERGIZES 'A' RELAY, THRU SWINGING TARGET UNIT DISC.

## SET-UP

IS ENERGIZED BY WIPER ON SWINGING TARGET UNIT DISC.

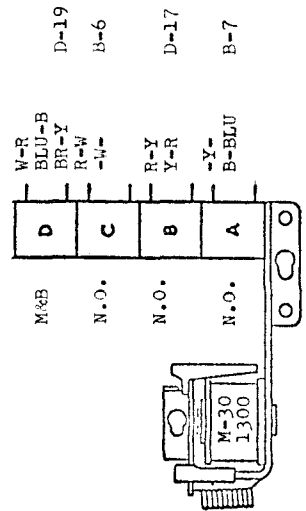

D-19 OPENS TO 100 POINT RELAY AND CLOSES TO 1,000 POINT RELAY.

B-6 TO TOP CENTER ROLLOVER LITE.

D-17 IN CIRCUIT TO EXTRA BALL RELAY.

B-7 TO SPINNER "1,000 POINT" LITE.

## EJECT

IS ENERGIZED BY TWO (2) EJECT POCKET SWITCHES.

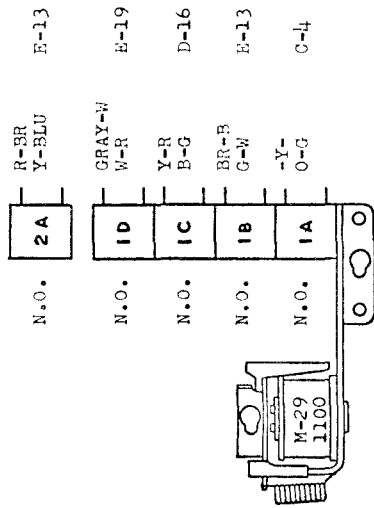

E-13 IN HOLD CIRCUIT TO THIS RELAY.

E-19 PULSES 100 POINT RELAY.

D-16 IN CIRCUIT TO DOUBLE BONUS RELAY.

E-13 ENERGIZES EJECT COILS AT SCORE MOTOR CAM SWITCH 4C.

C-4 RUNS SCORE MOTOR.

## 5000

IS ENERGIZED BY SWINGING TARGET UNIT END-OF-STROKE SWITCH, THRU WIPER ON SWINGING TARGET UNIT DISC.

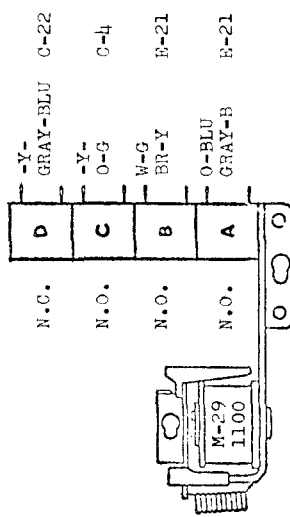

C-22 IN CIRCUIT TO ENERGIZE NO. MATCH S.U. COIL, THRU LONG DWELL CAM SWITCH 2B.

C-4 RUNS SCORE MOTOR.

E-21 PULSES 1,000 POINT RELAY.

E-21 IN HOLD CIRCUIT TO 5,000 POINT RELAY.

## 50 POINT

IS PULSED BY RIGHT TOP STAND-UP SWITCH OR LEFT AND RIGHT SIDE STAND-UP SWITCHES.

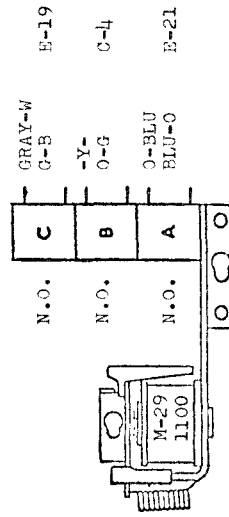

E-19 PULSES 10 POINT RELAY.

C-4 RUNS SCORE MOTOR.

E-21 IN HOLD CIRCUIT TO THIS RELAY.

## SHOOTER

IS ENERGIZED BY TWO (2) SHOOTER SWITCHES.

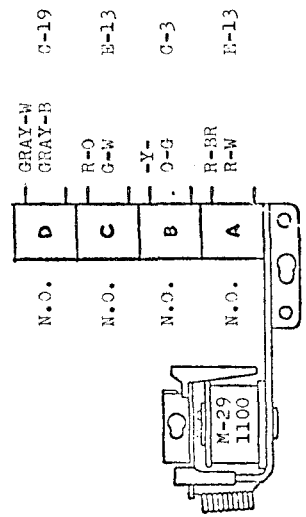

C-19 IN SERIES WITH SWITCH 'E' ON 'E' RELAY.

E-13 PULSES SHOOTER COILS, THRU SCORE MOTOR CAM SWITCH 4C.

C-3 RUNS SCORE MOTOR.

E-13 IN HOLD CIRCUIT TO THIS RELAY.

# LOCATED IN BACK-BOX

## 3&4 RESET

IS ENERGIZED BY IMPULSE CAM SWITCH 'A',  
THRU SWITCH ON RESET RELAY.

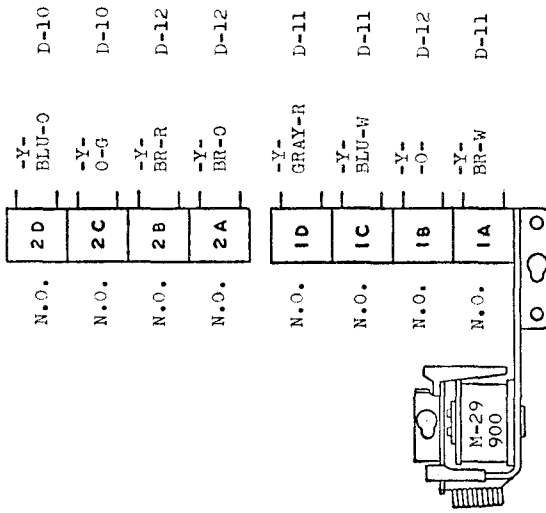

THESE SWITCHES PULSE  
THE INDICATED DRUM  
UNIT, THRU ZERO SWITCH  
ON THAT UNIT.

## 1&2 RESET

IS ENERGIZED BY IMPULSE CAM SWITCH 'A'  
(FORWARD), THRU SWITCH ON RESET RELAY.

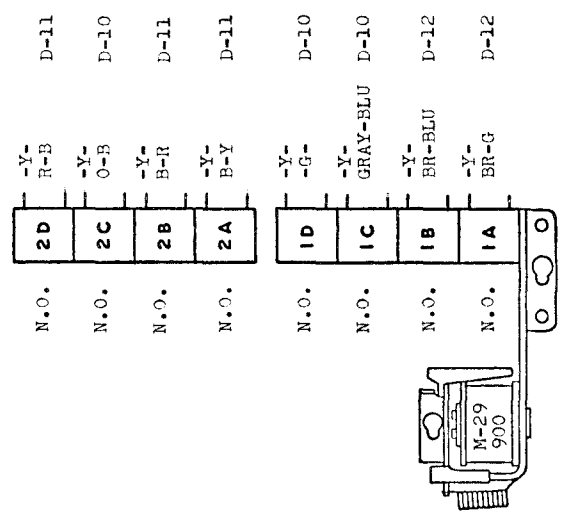

THESE SWITCHES PULSE  
THE INDICATED DRUM  
UNIT, THRU ZERO SWITCH  
ON THAT UNIT.



## 1000 POINT

IS PULSED BY:

- 5,000 RELAY
- END-OF-STROKE SWITCH ON SWINGING TARGET UNIT, THRU WIPER ON THAT UNIT.
- ADVANCE RELAY, THRU "ADVANCE BONUS ADJUSTMENT" JACK.
- SPINNER SWITCH, THRU SET-UP RELAY.
- LEFT OR RIGHT BOTTOM ROLLER SWITCH.
- BONUS RELAY (WHEN COLLECTING BONUS).

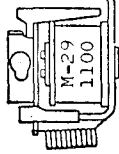

N.C.	2C	-J- -Y-	C-18	IN SERIES WITH SWITCH 2B ON 100 POINT RELAY.
N.O.	2B	BR-G GRAY-R	D-15	ENERGIZES BALL INDEX RELAY, THRU BONUS UNIT DISC.
N.O.	2A	BLU-R BR-Y	E-22	IN HOLD CIRCUIT TO THIS RELAY.
N.O.	1D	W-O -BR-	C-12	PULSES 10,000 POINT DRUM UNITS, THRU 9TH POSITION SWITCHES ON 1,000 POINT DRUM UNITS.
N.O.	1C	W-O -H-	C-11	PULSES 1,000 POINT DRUM UNITS, THRU PLAYER UNIT DISC.
N.O.	1B	-Y- B-G	C-13	PULSES LARGE CHIME COIL.
N.O.	1A	-BLU- B-W	F-9	IN HI-SCORE CIRCUIT TO "PLAY ADJUSTMENT JACK". (CREDIT OR EXTRA BALL).

## 100 POINT

IS PULSED BY:

- (2) JET BUMPER SWITCHES.
- SPINNER SWITCH, THRU SET-UP RELAY.
- SHOOTER RELAY, THRU SWITCH ON 'B' RELAY.
- EJECT RELAY.
- LEFT AND RIGHT TOP ROLLER SWITCH.

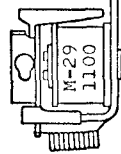

N.C.	2B	-J- -J-	C-18	IN SERIES WITH SWITCH 2B ON 100 POINT RELAY.
N.O.	2A	W-B W-R	E-20	IN HOLD CIRCUIT TO THIS RELAY.
N.O.	1D	R-G W-O	C-11	PULSES 100 POINT DRUM UNITS, THRU PLAYER UNIT DISC.
N.O.	1C	O-R -Y-	C-12	TO SMALL CHIME COIL.
N.O.	1B	BR-G GRAY-R	D-15	ENERGIZES BALL INDEX RELAY, THRU BONUS UNIT DISC.
N.O.	1A	O-BLU BR-Y	E-22	PULSES 1,000 POINT RELAY, THRU 9TH POSITION SWITCHES ON 100 POINT DRUM UNITS.

## 10 POINT

IS PULSED BY THREE (3) STAND-UP SWITCHES AND BY 50 POINT RELAY.

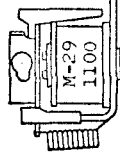

N.C.	2B	GRAY-Y -J-	D-18	IN SERIES WITH SWITCH 'A' ON EXTRA BALL RELAY.
N.O.	2A	W-BLU G-B	E-19	IN HOLD CIRCUIT TO THIS RELAY.
N.O.	1D	W-O BR-O	C-10	PULSES 10 POINT DRUM UNITS, THRU PLAYER UNIT DISC.
N.O.	1C	-Y- -O-	C-13	TO MEDIUM CHIME COIL.
N.O.	1B	BR-G GRAY-R	D-15	ENERGIZES BALL INDEX RELAY, THRU BONUS UNIT DISC.
N.O.	1A	W-R B-G	E-20	PULSES 100 POINT RELAY, THRU 9TH POSITION SWITCHES ON 10 POINT DRUM UNITS.

### 4TH PL. 100,000

LATCH COIL STAYS ENERGIZED AS LONG AS RESET RELAY IS IN.

TRIP COIL IS ENERGIZED BY 1,000 POINT RELAY, THRU PLAYER UNIT DISC AND 9TH POSITION SWITCHES ON 1,000 AND 10,000 POINT DRUM UNITS OF 4TH PLAYER.

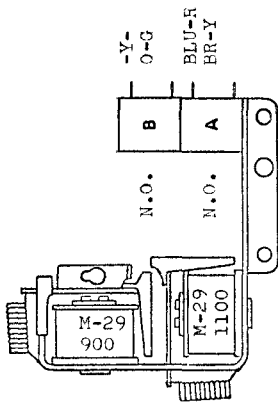

B-3 TO 4TH PLAYER 100,000 LITE.  
E-9 IN HI-SCORE CIRCUIT FOR 4TH PLAYER.

### 3TH PL. 100,000

LATCH COIL IS ENERGIZED AS LONG AS RESET RELAY IS IN.

TRIP COIL IS ENERGIZED BY 1,000 POINT RELAY, THRU PLAYER UNIT DISC AND 9TH POSITION SWITCHES ON 1,000 AND 10,000 POINT DRUM UNITS OF 3RD PLAYER.

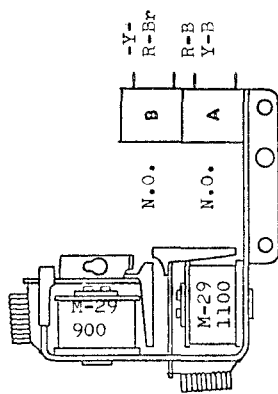

B-3 TO 3RD PLAYER 100,000 LITE.  
E-9 IN HI-SCORE CIRCUIT FOR 3RD PLAYER.

### 2ND PL. 100,000

LATCH COIL IS ENERGIZED AS LONG AS RESET RELAY IS IN.

TRIP COIL IS ENERGIZED BY 1,000 POINT RELAY, THRU PLAYER UNIT DISC AND 9TH POSITION SWITCHES ON 1,000 AND 10,000 POINT DRUM UNITS OF 2ND PLAYER.

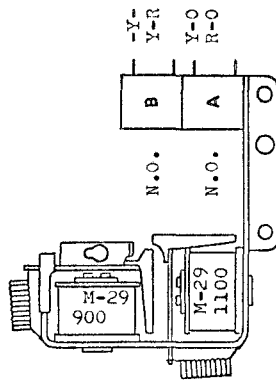

B-3 TO 2ND PLAYER 100,000 LITE.  
E-9 IN HI-SCORE CIRCUIT FOR 2ND PLAYER.

### 1ST PL. 100,000

LATCH COIL IS ENERGIZED AS LONG AS RESET RELAY IS IN.

TRIP COIL IS ENERGIZED BY 1,000 POINT RELAY, THRU PLAYER UNIT DISC AND 9TH POSITION SWITCHES ON 1,000 AND 10,000 POINT DRUM UNITS OF 1ST PLAYER.

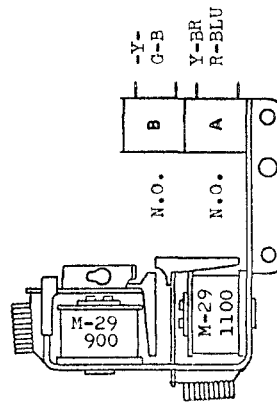

B-2 TO 1ST PLAYER 100,000 LITE.  
E-9 IN HI-SCORE CIRCUIT FOR 1ST PLAYER.



PRINTED  
IN  
U.S.A.